

Owner's Manual

INCLUDES

User, Maintenance, Service, and Installation
Instructions



CORE Slide & Remote Control



Please keep this booklet for service log and future reference

IMPORTANT



This appliance is guaranteed for 12 months subject to conditions. The 5 year extended parts warranty will only be valid if the annual service recommended in this manual has been completed and appliance has been registered online.

For use in Great Britain.

Literature NO 7931 (Iss. 14)

Contents

EXTENDED FIVE YEAR PARTS WARRANTY	2
Benchmark Scheme	3
SECTION ONE Introduction (user instructions)	5
SECTION TWO Operating the Appliance Slide Control	7
SECTION TWO Operating the Appliance Remote Control	8
SECTION THREE Cleaning (user instructions).....	10
SECTION FOUR Fuel Bed Cleaning and Layout (user instructions).....	11
SECTION FIVE General Points (user information).....	17
SECTION SIX Appliance Data (installation instructions).....	24
SECTION SEVEN Regulations and Warnings Continued (installation instructions)	25
SECTION EIGHT Siting the Appliance (installation instructions).....	26
SECTION NINE To Install the Appliance (installation instructions).....	30
SECTION TEN Checking Operation of Fire (installation instructions).....	33
SECTION TEN Checking Operation of Fire (installation instructions)	37
SECTION ELEVEN Maintenance Instructions (maintenance instructions).....	41
Short Spares List.....	43
GAS FIRE COMMISSIONING CHECKLIST.....	50
SERVICE RECORD.....	51



EXTENDED FIVE YEAR PARTS WARRANTY

In order to validate your extended 5 years parts warranty please read the Benchmark Scheme on the opposite page and ensure your installer has filled in the appropriate checklist.

This in no way reduces your statutory rights

Your warranty commences from the date of purchase and you must retain your receipt or invoice as proof of a purchase date.

THIS EXTENDED WARRANTY SPECIFICALLY EXCLUDES GLASS AND SOFT REFRACTORY COMPONENTS, THE BULB AND ANY BATTERIES.

Terms and Conditions

1. The appliance must be installed by a GAS SAFE registered person.
2. The appliance must be used in accordance with the user's instructions.
3. The appliance must be serviced annually by a GAS SAFE registered person.
4. The benchmark and service log must be correctly filled out and the record of annual services must be up to date and supported by receipts in each case.
5. This warranty is not transferable and relates to the original installation only.
6. The appliance has not been subjected to misuse or accident or been modified or repaired by any person other than the authorised employee or authorised representative of Charlton and Jenrick Ltd.
7. The registration form must be returned within 1 month of purchase.

Technical Help Desk 01952 200 444

Benchmark Scheme



Charlton and Jenrick Ltd is a licensed member of the Benchmark Scheme which aims to improve the standards of installation and commissioning of domestic heating and hot water systems in the UK and to encourage regular servicing to optimise safety, efficiency and performance. Benchmark is managed and promoted by the Heating and Hotwater Industry Council. For more information and the full code of practice please visit www.centralheating.co.uk

Please ensure that the installer has fully completed the Benchmark Checklist on the inside back pages of the installation instructions supplied with the product and that you have signed it to say that you have received a full and clear explanation of its operation. The installer is legally required to complete a commissioning checklist as a means of complying with the appropriate Building Regulations (England and Wales).

All installations must be notified to Local Area Building Control either directly or through a Competent Persons Scheme. A Building Regulations Compliance Certificate will then be issued to the customer who should, on receipt, write the Notification Number on the Benchmark Checklist.

This product should be serviced regularly to optimise its safety, efficiency and performance. The service engineer should complete the relevant Service Record on the Benchmark Checklist after each service.

The Benchmark Checklist will be required in the event of any warranty.

It is a requirement that the gas fire is installed and commissioned to the manufacturer's instructions and the data fields on the commissioning checklist completed in full.

To instigate the guarantee, the gas fire needs to be registered with the manufacturer within one month of the installation.

To maintain the guarantee, it is essential that the gas fire is serviced annually by a Gas Safe registered engineer. The service details should be recorded on the Benchmark Service Interval Record and left with the householder.

Important

For future reference, we suggest you record the following details here and keep your receipt as proof of purchase. This information will be required, should you need to contact the helpdesk.

MODEL:	Core Range	Serial No.	
---------------	-------------------	-------------------	--

The above information can be found on the label attached to the packaging and on the data badge, which is located on the base of the appliance behind the control cover.

Retailer Name:	
Address:	
Date Of Purchase:	

Installer information is required, to register for the extended warranty

Name:	
Date of installation:	
Gas safe number:	

SECTION ONE Introduction (user instructions)

Consumer protection information

As manufacturers and suppliers of heating products, we take every care, as far as is reasonably practicable, that these products are so designed and constructed as to meet the general safety requirement when properly installed and operated. To this end, our products are thoroughly tested and examined before despatch.

IMPORTANT NOTICE: Any alteration that is not approved by the appliance manufacturer could invalidate the approval of the appliance, operation of the warranty and could affect your statutory rights.

Health and safety notice

Important

This appliance could contain some of the materials indicated below, that could be interpreted as being injurious to health and safety. It is the users / installers responsibility to ensure that the necessary personal protective clothing is worn when handling these materials, see below for information.

Artificial Fuels, Mineral Wool, Insulation Material, Refractory/Ceramic Fibres, Glass Yarn - *may be harmful if inhaled, may be irritating to skin, eyes, nose and throat.*

When handling *avoid inhaling and contact with skin or eyes. Use disposable gloves, facemasks and eye protection. After handling wash hands and other exposed parts. If a vacuum is used for cleaning the coals or cleaning after servicing / installation it is recommended that it be of the type fitted with a HEPA filter.*

Disposal of refractory/ceramic materials. To keep dust to a minimum, these materials should be securely wrapped in polythene and be clearly labelled 'RCF waste'. These materials are not classified as 'hazardous waste' and should be disposed of at a site licensed for the disposal of industrial waste.

Introduction

- The PARAGON CORE has been designed and tested for use in GB (Great Britain).
- The PARAGON CORE incorporates a single gas control, which selects ignition pilot, and main burner low and high settings.
- The PARAGON CORE REMOTE incorporates a single gas control, which selects ignition pilot, with variable setting between low and high settings and is operated via remote control. The system is powered by a battery pack; therefore, no mains electrical supply is required.
- The PARAGON CORE incorporates a safety device in the form of an Oxygen Depletion System, which constantly monitors the oxygen in the room and will cause the fire to switch off if the oxygen level reduces, for instance, due to insufficient ventilation or a blocked flue.

If this regularly occurs, do not attempt to relight the appliance until a qualified engineer has inspected it, the problem may not be due to lack of air, or a defective flue.

Like all appliances incorporating an aerated burner, a low frequency noise may be heard, this may be more noticeable on the low setting. To obtain an authentic fire sound, a noise may be noticeable from the burner.

Important Information

- The appliance is available in **Natural Gas (G20 @ 20 mbar)** or **LPG (G31 @ 37mbar)** The marking (**G20 for natural gas**) or (**G31 for LPG**) on the packaging and the data badge specify the gas for which the appliance has been factory set. **Note: These appliances should only be used on the appropriate gas specified. They are not suitable for conversion from one gas to the other.**
- The appliance is for use on Natural Gas (G20 @ 20mbar) or LPG (G31 @ 37mbar).
- The chimney or flue (unless new or previously used with a gas appliance) shall be swept before installation if it has been used for solid fuel.
- The fire front (fret) or fascia supplied must be used with this appliance.
- Failure to install appliance correctly could lead to prosecution.
- In GB (Great Britain), the appliance must be installed by a competent person i.e. gas safe registered, in accordance with the GAS SAFETY (INSTALLATION AND USE) REGULATIONS, The Building Regulations (or The Building Regulations (Scotland) or The Building Regulations) and The Current I.E.E. Wiring Regulations, if appropriate.
- The glass front of this fire acts as a dress guard, conforming to BS 1945 (1997) however; a fireguard conforming to BS6539 (1997) must be used to protect young children, the elderly or infirm.
- The appliance **MUST NOT** be used with the glass safety screen removed or if it is damaged or cracked.
- During initial firing, an odour may be evident. This is the starch binder used during the manufacture of the fibre components of the fire, and there are **no harmful** effects produced.
- During the normal operation of the fire some black staining may appear on some parts of the fuel bed. This is quite normal and adds to the appearance of the appliance. However, if excessive black staining does occur it may be due to the fuel bed being incorrectly laid. This should be checked prior to contacting a service engineer.
- Care must be taken to prevent any damage being caused to surrounding soft furnishing or decoration; e.g. many embossed vinyl wall coverings may become discoloured if placed too close to the appliance. Combustible material i.e. wall panelling or wallpaper must be removed from behind the fire and fire trim.
- It is advised that this appliance is serviced annually; as it is more likely to provide trouble-free operation.
- In GB (Great Britain) the fire does not normally require purpose-built ventilation, but if for any special reason, purpose built ventilation is provided, it should be checked periodically to ensure freedom from obstructions.

SECTION TWO Operating the Appliance Slide Control

The full lighting procedure is as follows and the user should be in a standing position when operating the control.

- A. Push slide control lever down as far as possible, a clicking noise will be heard and the pilot will light. **HOLD DOWN FIRMLY FOR 20 SECONDS.** Prior to lifting the lever, push down more firmly for a few seconds.
- B. Pull lever up and the pilot light should remain alight, the main burner should light on its low setting.
- C. Should the pilot fail to light, pull the lever fully up to turn off the appliance, wait 3 minutes and repeat the procedure (A & B). If the pilot does not light, and no clicking noise is heard, replace the batteries with good quality alkaline batteries (such as Energizer) and try again.
- D. After lighting the pilot flame and the main burner on its low setting, the control lever may be lifted until slight resistance is felt, this will put the burner on its high setting.
- E. To completely extinguish the fire, pull the lever up past the resistance to its fullest extent.
- F. The fire may be operated on either its low or high setting.
- G. It is recommended that the appliance is operated on its high setting for a short period, before adjusting to the low setting.
- H. If the ignition does not operate, fit a new good quality 9V alkaline battery (PP3/MN1602) to the ignition unit, located behind the fret, adjacent to the gas inlet pipe, and repeat ignition procedure prior to reporting a fault.

Note: - If the ignition fails, the pilot can be lit with a taper or a match held at the pilot head.



Important Information

- If the fire goes out for any reason, or it is turned off and is to be turned on again, it is necessary to wait three minutes before attempting to re-light.
- **The spillage monitoring system will operate if the flue does not work or becomes blocked.**
- **If the fire repeatedly goes out during use, this may be due to lack of ventilation or a blocked flue. Expert advice should be obtained.**
- **Do not use the fire with the glass safety screen removed, or if the glass is cracked.**

SECTION TWO Operating the Appliance Remote Control

Before attempting to operate the appliance check that nothing has been placed in front of the appliance that may interfere with the remote sensor operation.

To light the appliance using the remote handset:

- A. Point the remote control handset in the direction of the appliance and simultaneously press the buttons marked OFF '●' and 'STAND-BY'. Continue to hold in these two buttons until a 'bleep' is heard (approximately 2-3 sec.) and then release these buttons. The appliance will automatically go through the ignition sequence and the pilot should ignite. Once the pilot is alight, the appliance will automatically go to the high setting (approximately 20-25sec). If the ignitor stops sparking and the pilot fails to light, repeat this procedure.
- B. The appliance can be adjusted up or down by pressing the appropriate button  (LOW setting) or  (HIGH setting). There are 5 heat settings and the fire will give a double bleep when the maximum or minimum heat setting is reached. To switch off the appliance press the OFF ● button or if the appliance is to be switched off for a short period it is recommended that the 'standby' button be used. This switches the main burner off but leaves the pilot on and will extend battery life.
- C. The appliance can be switched off without using the handset by removing the appliance batteries located behind the ash pan cover. When the batteries are removed there will be a delay (up to 3minutes) after which double beeps may be heard and shortly after the appliance will extinguish. Ensure that the battery is re-connected once the fire has been extinguished. The appliance cannot be operated without the use of the handset. If the fire fails to light or extinguishes for any reason, it will be necessary to re-set the fire. This can be done by pressing the OFF '●' button following the normal lighting procedure.

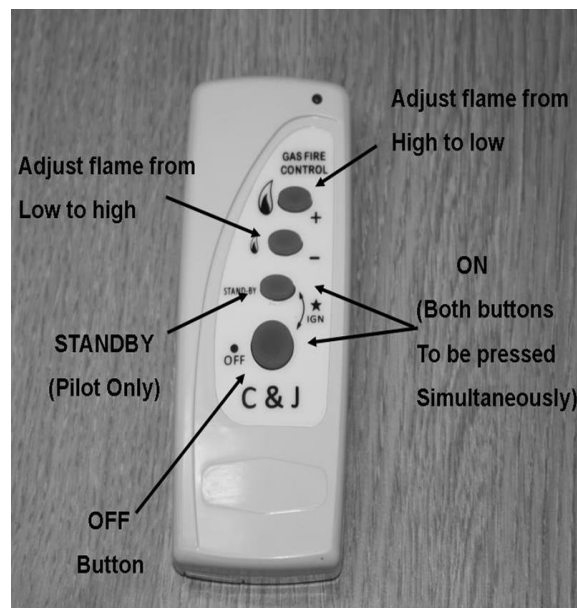

Note: If repeated delayed ignition is experienced during start-up, it is recommended that the appliance is checked by a Gas Safe engineer

NOTE: If the fire is extinguished for any reason wait 3 minutes before relighting.

Low Battery Indication (Handset)

If, while pressing any of the buttons on the remote handset, the low battery indicator lamp either stops flashing or appreciably slows, then the batteries should be changed. Replace the batteries with good quality alkaline batteries (such as Energizer)

To Replace Batteries In The Handset (AAA 1.5 v Ir3 X2)

Remove the cover from the rear of the handset and fit replacement batteries, taking care not to strain the battery connections. Ensure that the battery terminals are placed correctly.

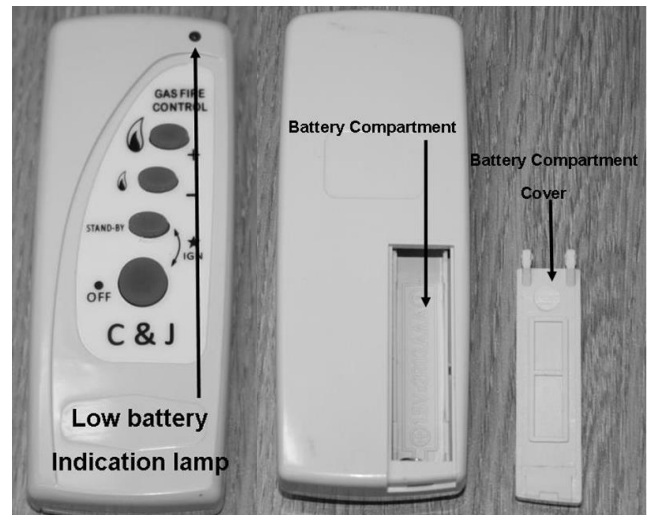

LOW BATTERY INDICATION (APPLIANCE)

If you hear a repeated 'bleep' sound come from the appliance, this indicates the appliance battery pack is low and should be changed as soon as possible. The appliance will continue to work normally for a short period, but if the warning is ignored you may experience difficulty lighting the appliance, or the appliance may automatically switch off for no apparent reason.

NOTE: The appliance cannot be used when the battery is completely flat.

TO REPLACE APPLIANCE BATTERIES (6 High Power Alkaline AA 1.5V)

(Rechargeable batteries can be used providing they are a nickel metal hydride type 1.5V AA with a minimum capacity of 2200mAh). Using AA Lithium batteries will give more operations.

- A. Lift off the fret and the ash pan.
- B. The battery power pack or holder is located at the left-hand side of the burner; carefully slide the battery holder forward and replace all six batteries as a complete set or recharge as appropriate.
- C. **WARNING, batteries will overheat if fitted incorrectly, when fitting the batteries ensure that they are fitted as per the marking on the rear of the holder (i.e. minus of battery against spring).** If rechargeable batteries are used, they MUST be a Nickel Metal Hydride type with a minimum capacity of 2200mAh.
- D. **IMPORTANT:** Place the battery pack on the left-hand side of the appliance and refit the fret and ash pan cover.
- E. Once the new batteries are loaded, the fire will continue to bleep until re-set. This can be done by pressing the "off" button on the handset, followed by the normal ignition sequence as above. If the fire continues to bleep, this may indicate a loose connection or incorrectly loaded batteries.

SECTION THREE Cleaning (user instructions)

WARNING: -

Before you clean any part of the appliance, please ensure that the appliance is **turned off and cold**. This could take 4 hours.

Cleaning: Trim, Fret or Fascia

Abrasive or chemical cleaner should **never** be used.

Cleaning: Black Painted Surfaces

- These surfaces should be dusted regularly, and any marks removed with a soft cloth.
- Abrasive or chemical cleaner should **never** be used.

REMOVING GLASS PANEL

- Remove the trim, which is held in position with magnets.
- Remove the fret and ash-pan cover.
- Remove the glass fixing clamp, secured with two securing nuts and lift it out of the retaining brackets. Take care to support the glass panel when removing the fixing clamp. The glass should be placed in a safe place to prevent damage.



Glass Cleaning

From time to time it will be necessary to clean the glass panel of your fire. We recommend you use a Ceramic hob cleaner. These are available from all leading supermarkets: - i.e. **ASDA, TESCO, SAINSBURY'S** Etc.

Brands of hob cleaning we have tested and found suitable are - **HOB BRITE & VITRO CLEN.**

- Ensure the fire has been turned OFF for at least four hours to ensure it is cool.
- Remove the glass panel as described above.
- Lay the glass panel down on a flat working surface on top of an old opened newspaper, with the side to be cleaned uppermost.
- Follow the instructions on the Ceramic Hob Cleaner bottle.
- Ensure all the residues of the cleaner are removed with a damp cloth and the glass panel is completely dry before re-fitting to the appliance.

Important:- The appliance must not be used if the glass panel is missing or damaged.

Note: - The glass may discolour quickly when first installed, and it should be cleaned. This is due to the burning off process of the refractory shapes.

SECTION FOUR Fuel Bed Cleaning and Layout (user instructions)

WARNING: -

- Before you clean any part of the appliance, ensure that the appliance is turned off and cold.
- Use only the fuel bed components provided. No additional parts must added.
- Incorrect positioning of the fuel bed components could result in the staining of the glass panel.

IMPORTANT: - Refer to the Health & Safety Notice located on page 5 of this booklet before cleaning or replacing any refractory material.

- The fuel bed components are delicate and they should be handled with great care.
- The loose parts and moulded shapes may be removed for cleaning. They can be brushed very gently with a soft brush to remove dust or any deposits.
- A vacuum cleaner may only be used after the loose components and moulded shapes have been removed.

It is important that all the fuel bed moulded shapes are positioned as shown in these instructions.

Fuel Bed Layout



Place the first shape on top of the locating pins as shown.



Spread a thin layer of vermiculite over the burner surface, taking great care not to block the pilot area.

Avoid Blocking Pilot Area & Cross Lighting Ports





Place the next shape on to the location pins as shown.

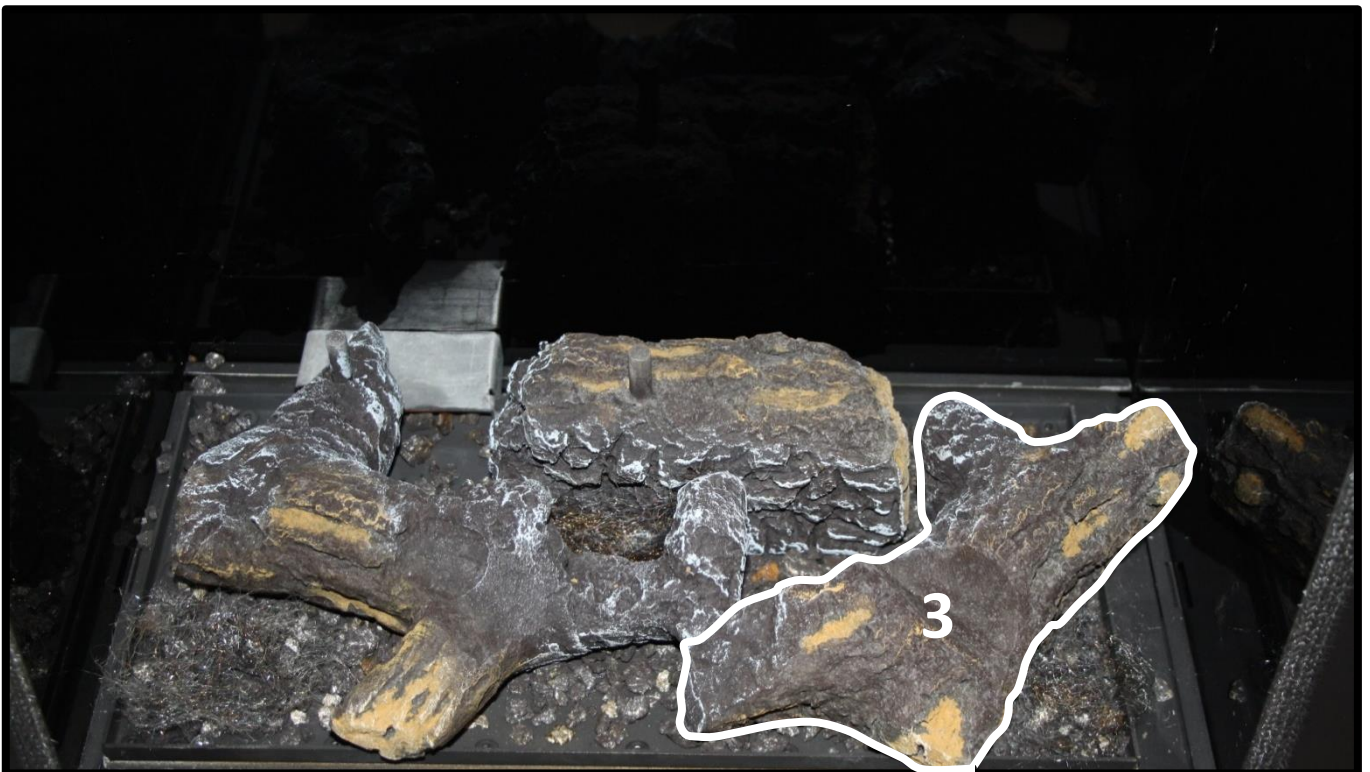

Place the final base piece on its location pins as shown.



Tease out half of the Emberglow to make a very loose network of fibres and place in the spaces between the shapes and above the burner ports as highlighted.



Place a further 2 log shapes as highlighted above. Log No.5 is a Y shaped log.



Place a further 2 log shapes as highlighted above.



Place a further 2 shapes as shown highlighted above.



Place the final two log shapes as shown, to complete the log layout.

LARGE LOG FUEL BED LAY OUT (NATURAL GAS ONLY)

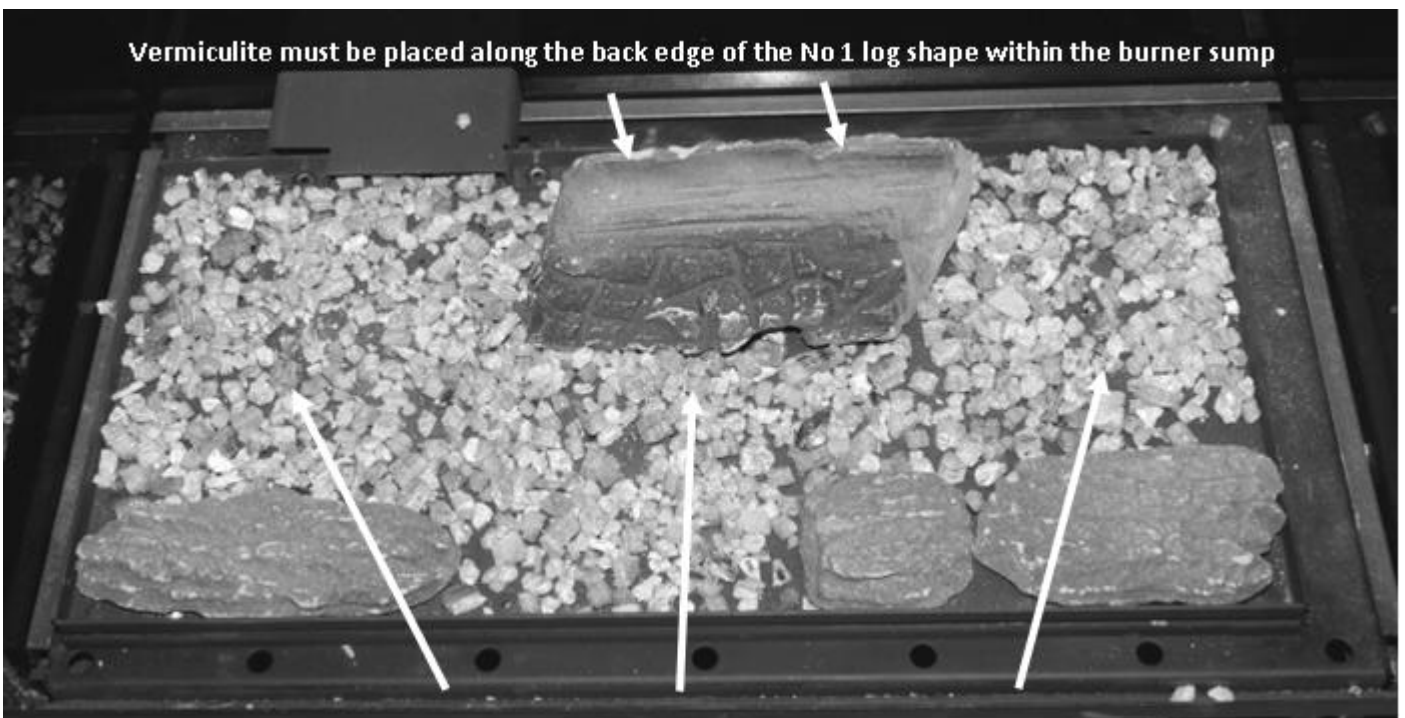
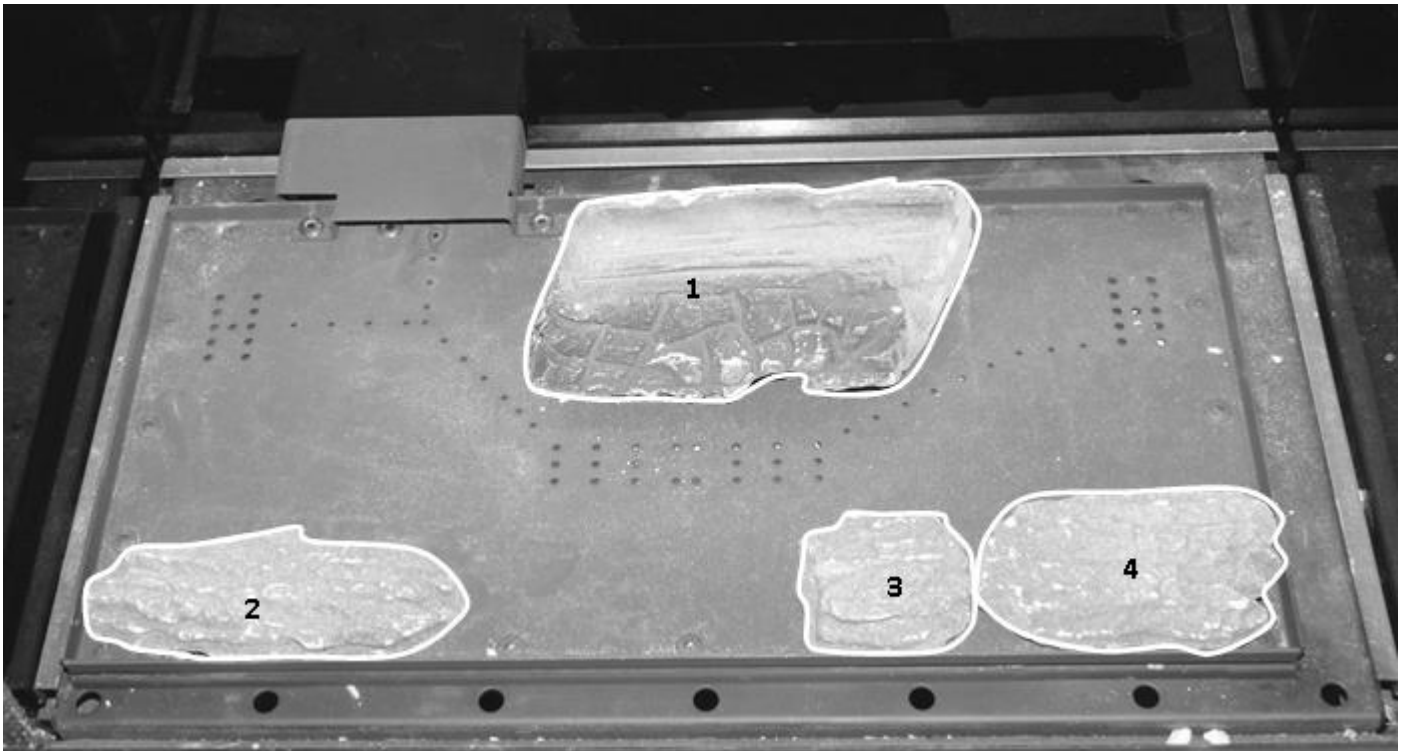

Place an even amount of vermiculite across the top of the burner. Keep pilot area clear.

DO NOT PLACE NEAR THE PILOT AREA

Tease out the Embaglow to form a very loose, very light network and place in the area shown below

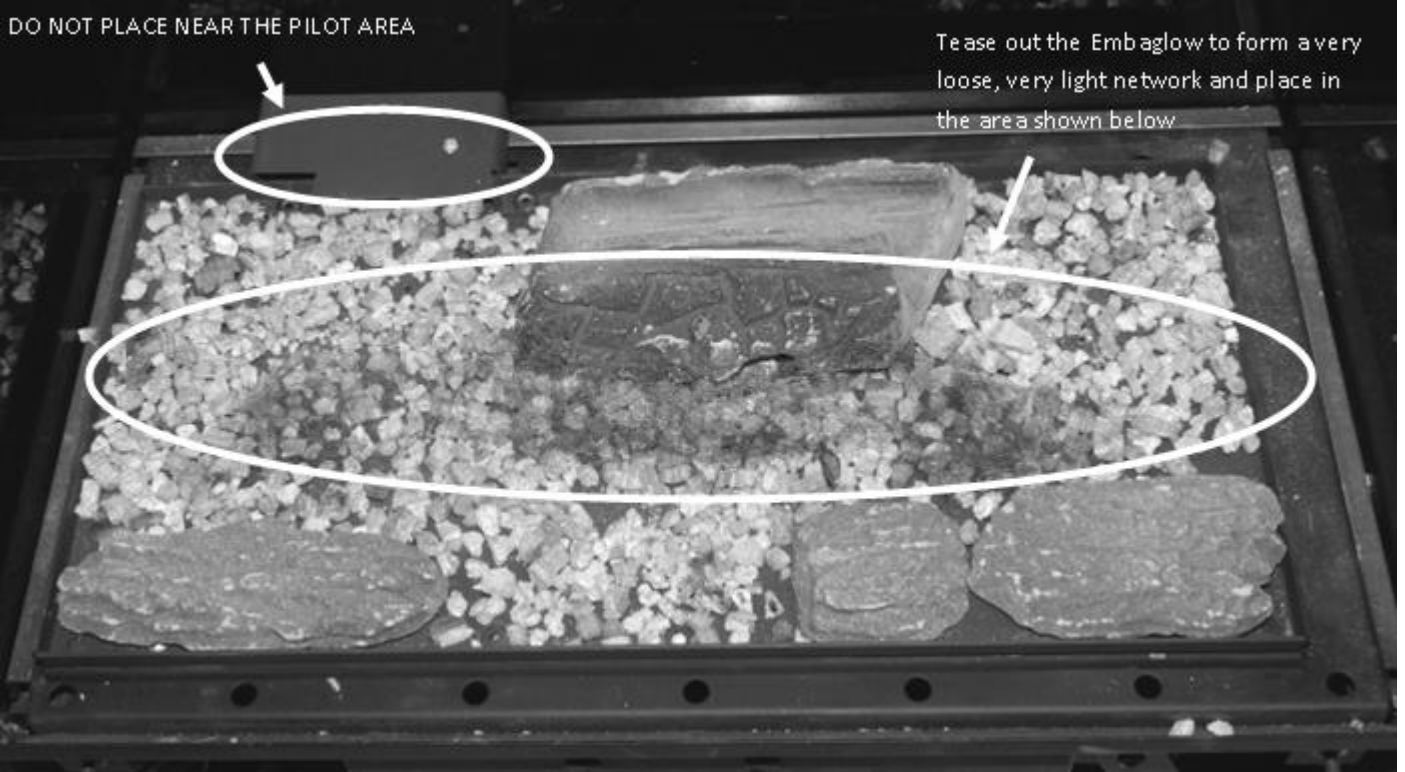

Locate the No 5 Shape directly upon the burner pilot shield and within the gap between the burner and the rear lining

Push the shape hard right against the pilot Shield. (Note:- failure to place the shape correctly can result in a uneven flame picture).

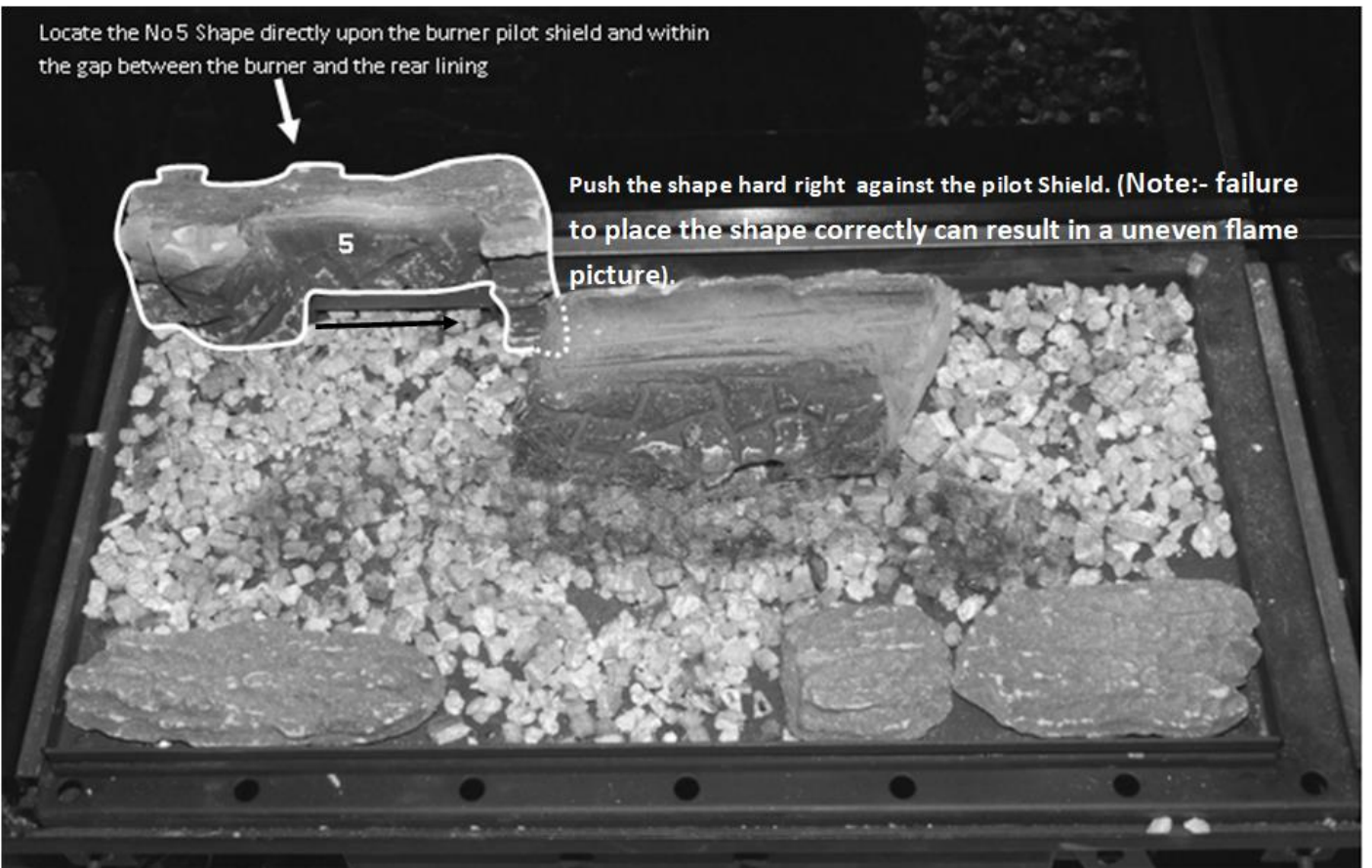

Please make sure the shape sits hard against the side of log No 5

Place the No 6 shape within the gap between the burner sump and the rear lining.

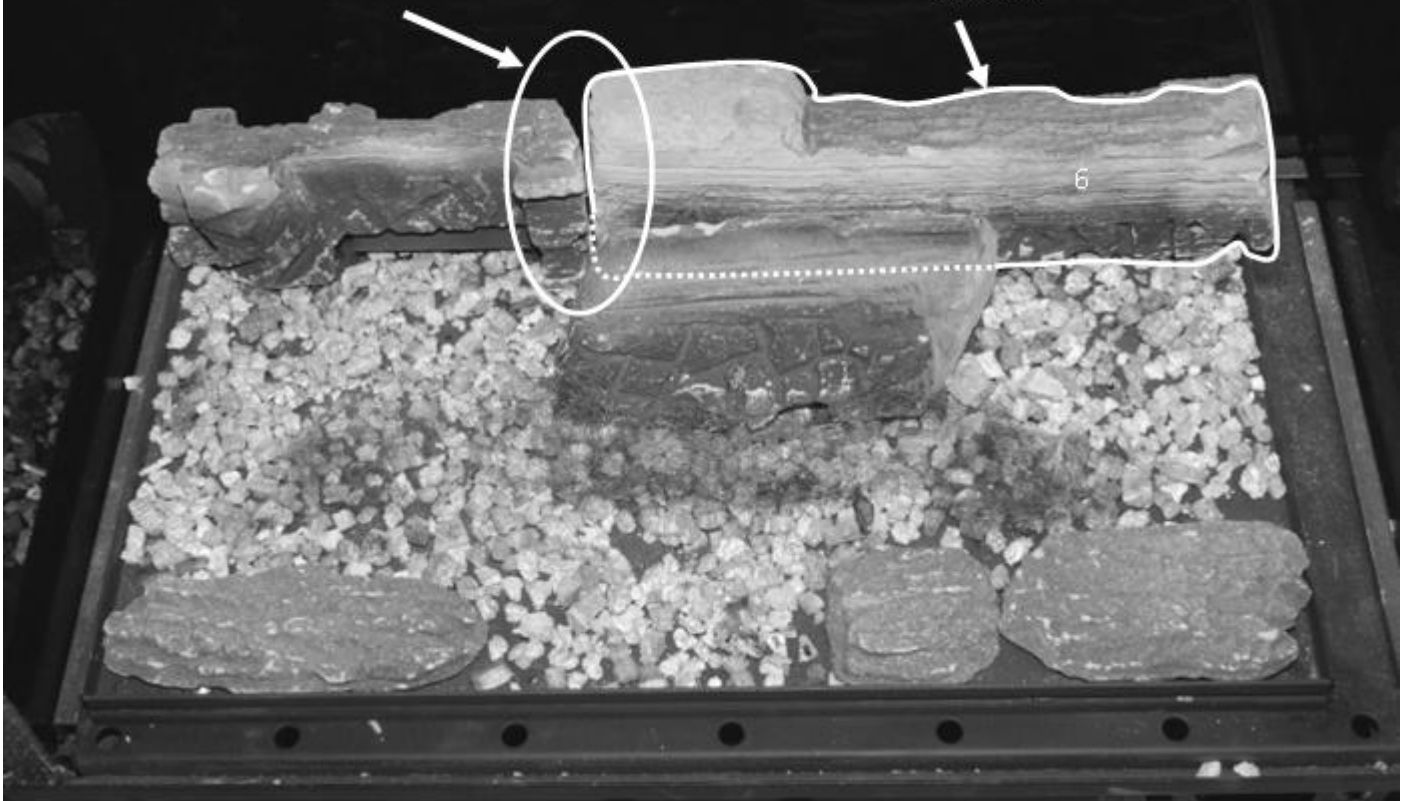

The No 8 shapes need to be position as shown with the flat face hard against the side glass panel and the No 5 log

Please note:- failure to position the shape correct can result in marking upon the side glass panel



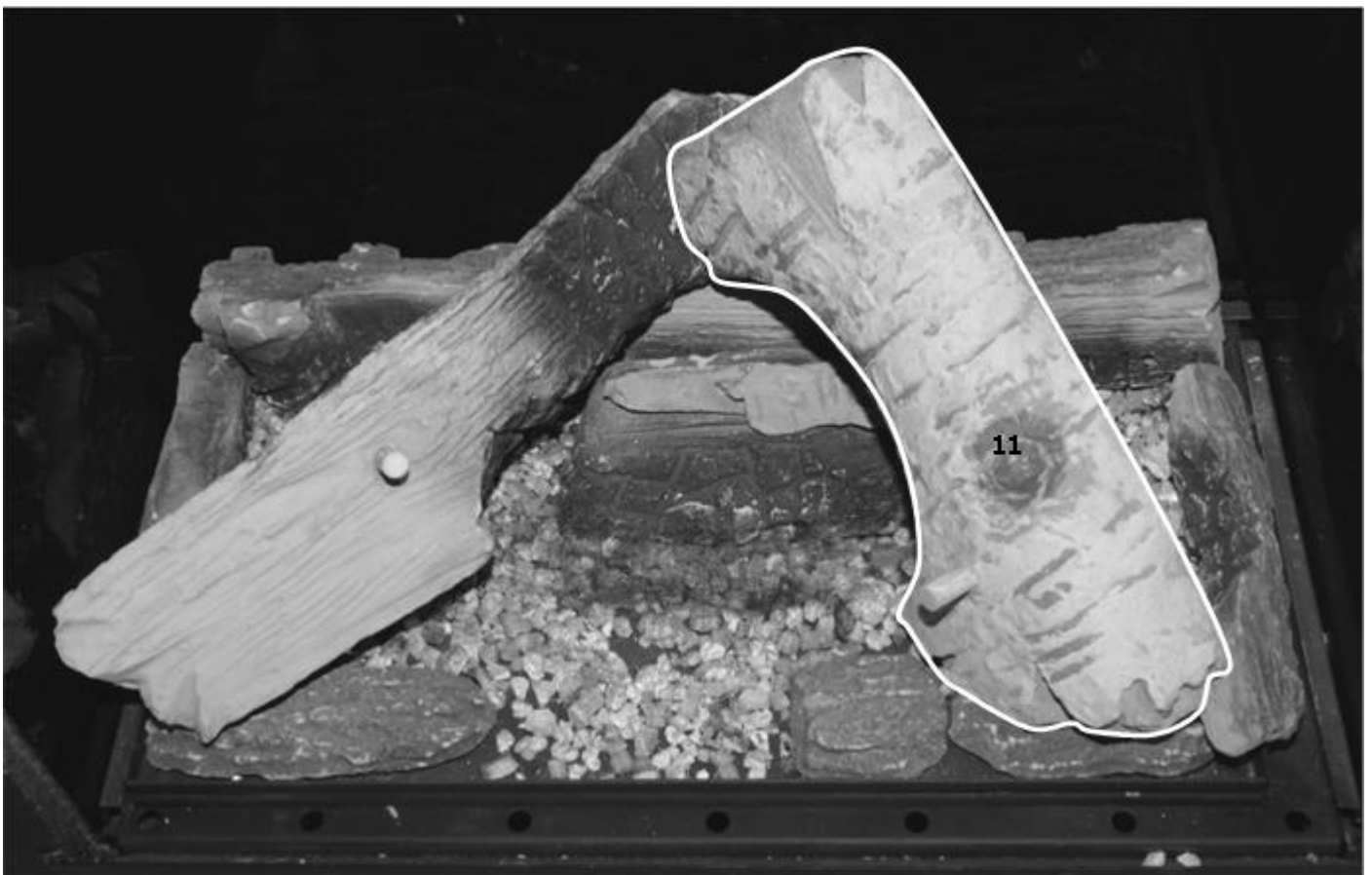
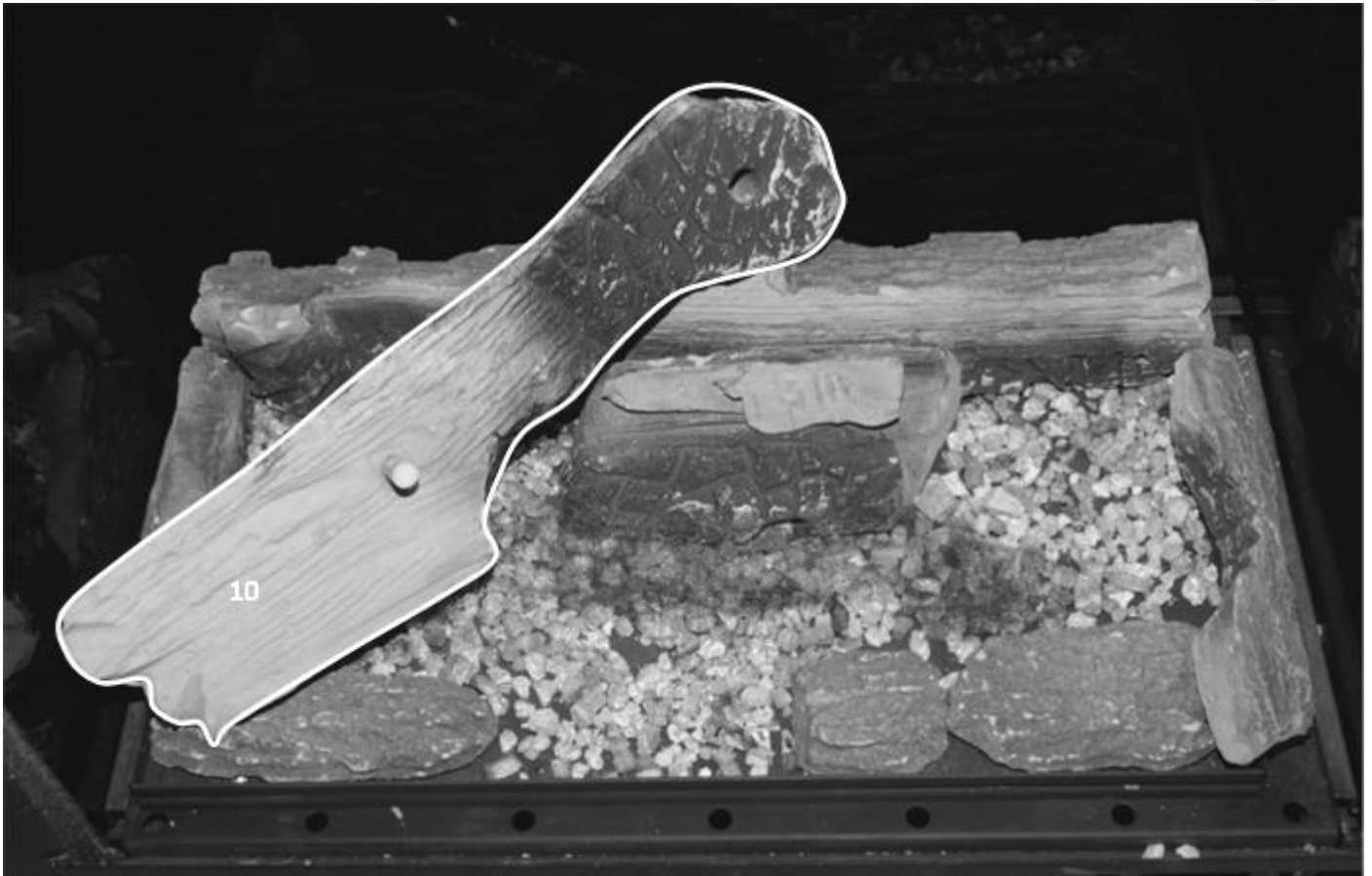



SECTION FIVE General Points (user information)

Like all appliances incorporating an aerated burner a low frequency noise may be heard, particularly on the low setting, this is quite normal and does not affect the operation of the appliance.

It is advised that a competent person service the Paragon Core fire annually. The fire is more likely to provide trouble-free operation.

Dulling and slight discoloration of the glass lining inside the firebox will occur. This is quite normal and the glass liners can be cleaned using hob bright or similar as you would cleaning the front glass panel.

It is important that: -

- The chimney or flue is checked annually to ensure clearance of combustion products.
- The fire front or fascia must be positioned in front of the fire whilst it is burning
- Any debris from the chimney or flue should be removed. The fire should be allowed to cool before it is removed.
- The fire must not be used if the glass panel is missing or damaged.
- The data badge is located on the base on the left hand side of the appliance base, behind the trim or fascia.

The only user removable parts are: -

- Fret
- Refractory Fire bed Components
- Fire trim.
- Glass panel.

SECTION SIX Appliance Data (installation instructions)

	NATURAL GAS	LPG
Gas Type:.....	CATEGORY I 2 H	CATEGORY I3P
Gas Pressure:.....	20 mbar +/- 1.0mbar	37 mbar +/- 1.0mbar
Pressure Test Point Location:.....	Gas inlet elbow	Gas inlet elbow
Gas Input:.....	5.3 kW Gross (Max.)	5.0 KW Gross (Max.)
	3.0 kW Gross (Min.)	3.3 KW Gross (Min.)
Injectors:.....	Mk 360A	Mk 116
Gas Connection:.....	8mm compression: semi-rigid or rigid	
Data Badge Location: ..	Located on the base of the appliance behind trim or fascia	

Appliance Dimensions

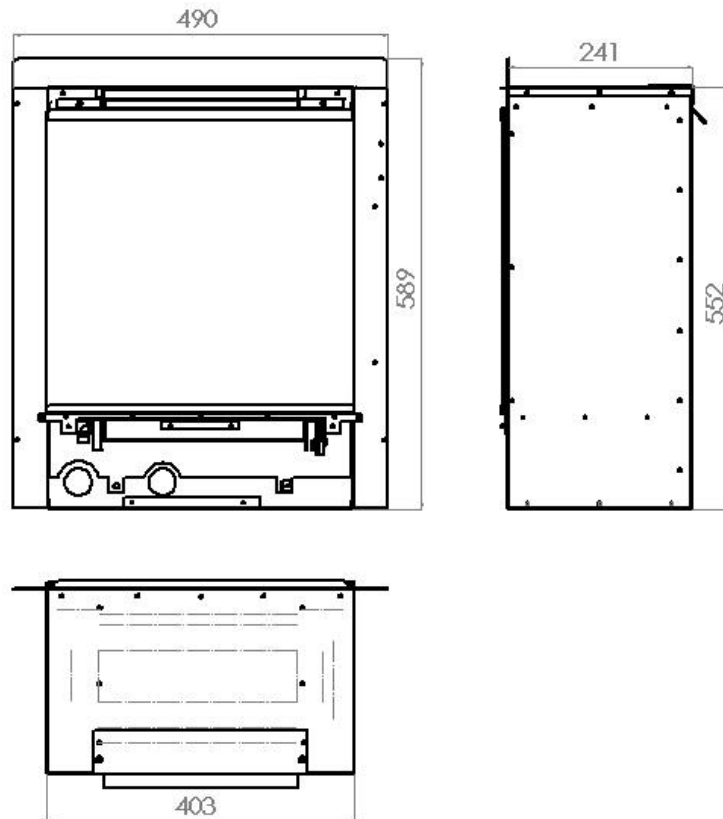

NOTE: The efficiency of this appliance has been measured as specified in BS7977-1 2009 + A1:2013 and the result is 71.7%. The gross calorific value of the fuel has been used for this efficiency calculation. GasTec have certified the test data from which it has been calculated. The efficiency value may be used in the UK Government's Standard Assessment Procedure (SAP) for energy rating of dwellings.

The restrictor on the top rear of the appliance (secured with 2 screws) is to be left in place subject to a successful spillage test.

Please note: removal of the restrictor on strong performing flues can result in the appliance outing under some conditions. It is strongly recommended to leave the restrictor in place, subject to a successful spillage test result.

When unpacking the appliance please check the following items are included:

Fuel Bed, Wire Fixing Kit (Including magnets & restrictor elbow), Foam sealing strip, Owner's Manual,

SECTION SEVEN Regulations and Warnings Continued (installation instructions)

- This appliance must only be installed in Great Britain.
- Confirm that the appliance is suitable prior to installation *G20 for natural gas or G31 for LPG* (refer to data badge on base of appliance). *Note: the appliance should only be used on the appropriate gas specified. It is not suitable for conversion from one gas to the other.*
- **GB (Great Britain)** This fire does not normally require purpose build ventilation.
- In GB, (Great Britain)

It is the law that all gas appliances must be installed by a competent person; i.e. a GAS SAFE registered installer, in accordance with the Current Gas Safety (Installation And Use) Regulations (as amended), all relevant parts of the local and national building regulations and all relevant recommendations of the following British Standards. Failure to do so could lead to prosecution.

The following are relevant codes of practice and British Standards: -

B.S. 5871

B.S. 5440 PART 1 & PART 2

B.S. 6891

This appliance must be installed to current versions of the above standards and include any relevant amendments to:-

The Building Regulations Issued By The Department Of The Environment.

The Building Standards (Scotland) (Consolidated) Regulations Issued By The Scottish Development Office.

- Prior to the installation ensure that the local distribution conditions (identification of type of gas and pressure) and adjustment of the appliance are compatible. G20 @ 20mbar or G31 @ 37mbar

IMPORTANT NOTE: - The fire front (fret) or fascia supplied must be used with this appliance.

WARNINGS

- The glass front of the fire act as a dress guard, conforming to BS 1945 (1971) and satisfies the heating appliance regulations (1991) However, a guard conforming to BS6539 (1984) must be used to protect young children, the elderly or infirm.
- **This appliance incorporates a safety device in the form of an Oxygen depletion system. IT MUST NOT BE ADJUSTED OR PUT OUT OF OPERATION! THIS IS A NON-SERVICABLE ITEM AND MUST BE EXCHANGED AS A COMPLETE ASSEMBLY; USING ONLY THE ORIGINAL MANUFACTURER'S PART.**
- A non-combustible hearth must be provided to comply with the building regulations, or a suitable proprietary fire surround with a 150°C minimum rating.
- During initial firing, an odour may be evident. This is the starch binder used during the manufacture of the fibre components of the fire, and there are **no harmful** effects produced.
- Care must be taken to prevent any damage being caused to surrounding soft furnishing or decoration; e.g. many embossed vinyl wall coverings may become discoloured if placed too close to the appliance.

SECTION EIGHT Siting the Appliance (installation instructions)

CLASS ONE

That is a conventional brick or stone chimney as used for a solid fuel appliance with an effective cross-sectional dimension of 225 x 225 mm (9" x 9") or a lined flue with a minimum diameter of 125mm (5"). The chimney must have a minimum effective height of at least 3 metres. Any permanent flue restriction or variable dampers are to be removed or locked fully open. The chimney should be swept prior to installation if it has previously been used with solid fuel. This is not necessary if the flue has previously been used with a gas appliance or if it is a new installation.

Note: A brick or stone chimney with a 125 mm (5 ins) minimum diameter flue liner conforming to BS 715 may be used. Provided a suitable sealing plate is fitted to the base of the liner and the appliance does not restrict the opening into the liner.

CLASS TWO FABRICATED METAL

A double-walled or insulated metal flue box built to the requirements of BS 715 with an insulated flue having a minimum diameter of 125 mm (5 inches) and a minimum effective overall height of 3 metres (10 feet).

Note: Dampers or register plates must not restrict any of the above flues. The flue must only service a single appliance and not have any branches or traps, which may impede the natural draught. If a terminal is fitted it must be suitable for the purpose.

Surrounds

The fire can be fitted in either a conventional hearth (i.e. tile fireplace etc), plinth mounted, in a fire surround, or a hole-in-the-wall installation. If a hearth or plinth is used it **MUST** be non-combustible.

Purpose built superimposed fire-resistant hearths and back panels, specified as suitable by the manufacturers, may be used, or a suitable proprietary fire surround with a 150°C minimum rating.

The trim and fret supplied with the appliance determines the type of installation that can be accommodated. Check table below for installation compatibility.

IMPORTANT NOTE when the fire is installed without a fireplace or non-combustible back panel any wall surface or covering that comes in contact with the appliance and is not non-combustible must be removed.

Care should be taken to prevent any damage being caused to surrounding soft furnishings or decoration e.g. many wall coverings may become discoloured if placed too close to the appliance.

FIREPLACE OPENING

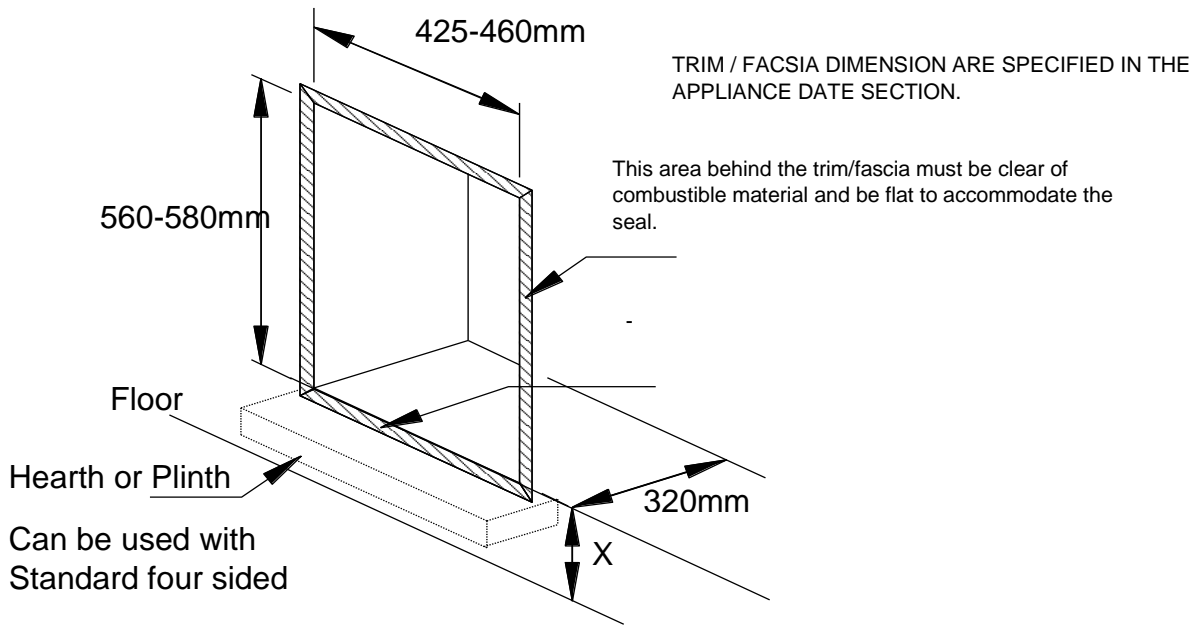

The front face and the base of the fire opening must be flat to ensure that a good seal is formed between the rear and base of the appliance and the chimney to avoid any reduction of natural draught.

	HEARTH OR PLINTH MOUNTED when fire fitted with STANDARD THREE SIDED TRIM		HOLE IN WALL (No Plinth) When fire fitted with STANDARD FOUR SIDED TRIM
Hearth / Plinth Size (Minimum Dimensions)	Width: 505mm Depth: 100mm Thick: 50mm		NA
'X' Height from floor to base of opening. (min.)	50mm		150mm
	Hearth or Plinth mounted only (It can fitted hole in wall but a plinth is required to support the trim and fret.)		
Hearth / Plinth Size (Minimum Dimensions)	Width: 520mm Depth: 100mm Thick: 50mm		
'X' Height from floor to base of opening. (min.)	50mm		
	Hearth Mounted	Hearth or Plinth mounted (It does not need a plinth to support the fascia but a plinth can be used for aesthetic purposes if required.)	Hole In Wall (No Plinth)
Hearth / Plinth Size (Minimum Dimensions)	Width: 6154mm Depth: 100mm Thick: 50mm	Width 615mm Depth 100mm Thick 50mm	NA
'X' Height from floor to base of opening. (min.)	50mm	50mm	150mm

Clearance to Shelf

Minimum clearance from hearth or base of opening to underside of combustible shelf should be 780mm provided the shelf depth is 100mm (4"). This gives a minimum clearance above the appliance of 170mm. For a shelf of 150mm (6") the minimum height above the hearth or base of opening must be 880mm. This will give a minimum clearance above the appliance of 270mm. For other depth refer to the shelf chart.

Clearance to Sides of Fire

Minimum width between vertical sides of combustible surround should not be less than 800 mm provided fire is central to the surround and sides do not project more than 150 mm. When vertical side forward projection is increased by 12.5 mm add 50 mm to inside width of surround.

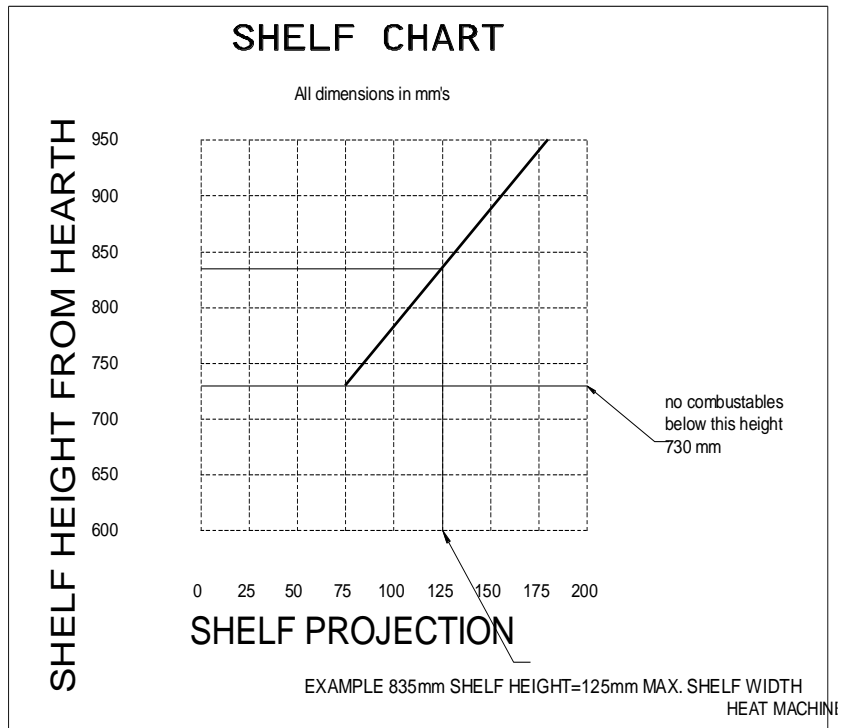

SECTION NINE To Install the Appliance (installation instructions)

CHECKING THE FLUE AND FIRE OPENING

- Check that the chimney conforms to the required specifications as previously stated. Examine the condition and carry out any remedial work including removing any debris from the base.
- If the flue has been used for solid fuel it should be swept prior to the installation
- Prior to installing the appliance a smoke test (using a smoke bomb) should be carried out to check that satisfactory smoke clearance has been established.

If all the smoke is not drawn into the flue, pre-heat the flue with a blowtorch or similar and re-check. If there is any uncertainty examine for the cause and, if necessary, seek expert advice.

No combustible material should be fitted inside the fireplace opening.

- When installing this appliance against a dry lined (plasterboard) wall ensure that any void between the plasterboard and the wall is sealed with a suitable non-combustible material (i.e. plaster or mortar).

GAS SUPPLY ROUTING

Use rigid or semi – rigid tube to connect the supply. Determine the gas supply pipe route to the appliance before installing the fire. We have provided inlet pipe entrance holes in the back of the fire. Use the left hole for the remote control version and the right for the slide control version. Contained in the fixing kit is a blind grommet to seal the unused hole.

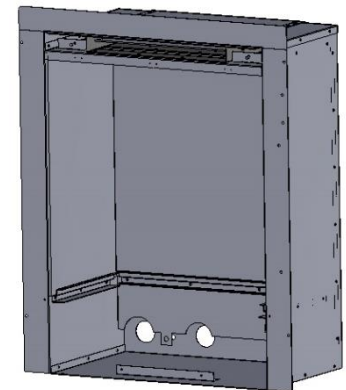

STANDARD TRIM & FRET

This may be from the front of the unit, either from the left or from the right hand, or it can be a concealed fitting from the rear of the appliance.

GLASS PANEL REMOVAL

- Refer to section 3

CONNECTING THE GAS SUPPLY

If it is intended to be a concealed connection the 8mm supply should be positioned in the opening first.

The pipe should be positioned so that when the appliance is pushed back into the opening it enters the grommet hole at least 180mm, taking into account the requirements of BS 6891 1988 dealing with enclosed pipes.

Note: - An isolation valve may be fitted in the gas supply adjacent to inlet pipe.

For a concealed connection: -

- Remove the burner assembly by undoing the fixing screws two in front control fascia and two on the ends of the front glass retaining bar. Slide the burner out from the fire.
- Remove the rubber (blind) grommet from the supply pipe inlet hole at the rear of the outer box and slide the box over the supply pipe and fix to the surround using one of the methods described in the next section.
- Refit the grommet over the pipe and seal around the inlet hole.
- Refit the burner unit and make connection between the supply isolating valve and the burner assembly inlet.

FIXING FIRE INTO OPENING

Method 1 (Screw Fix)

- Mark the position of flange holes required in the fireplace front, drill and insert wall plugs.
- Remove the paper back from the length of seal and stick it around the rear of the front flange of the fire.

NOTE: -The seal must be positioned to ensure an airtight seal when the appliance is fitted.

- Fix the firebox in position with screws.

Method 2 (CABLE FIXING SYSTEM)

- Using a 6mm masonry bit drill two holes in the rear wall within the range shown, fit rawl plugs provided and screw eyebolts securely into plugs.
- Remove paper back from length of seal around the rear flange of the fire.

NOTE: -The seal must be positioned to ensure an airtight seal when the appliance is fitted.

- Bend up the 2 wire fixing tabs on the top of the firebox.
- Position the fire close to fireplace, allowing sufficient access to thread the cable through the eyebolts. Feed the cables (one cable to each side) through the top holes in the firebox tabs, through the eyebolts, and back through the bottom holes in the firebox as shown.
- Push firebox fully back in the fireplace opening, allowing it to seal against it to seal against the surround.
- Feed the cables through the adjusters and cable clamps and slide the clamps up the adjusters. Pull the cable as tight as possible and tighten the cable clamps. With a spanner tighten up the adjuster nut to tension the cable and make good the seal.

Note: -

After fitting neatly coil up the excess cable.

DO NOT CUT OFF THE EXCESS CABLE.

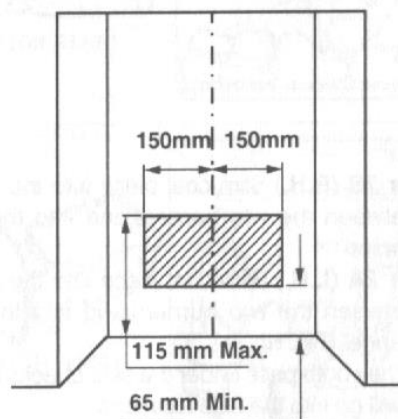

Drill holes for eye bolts on 112mm centre lines between maximum and minimum heights.

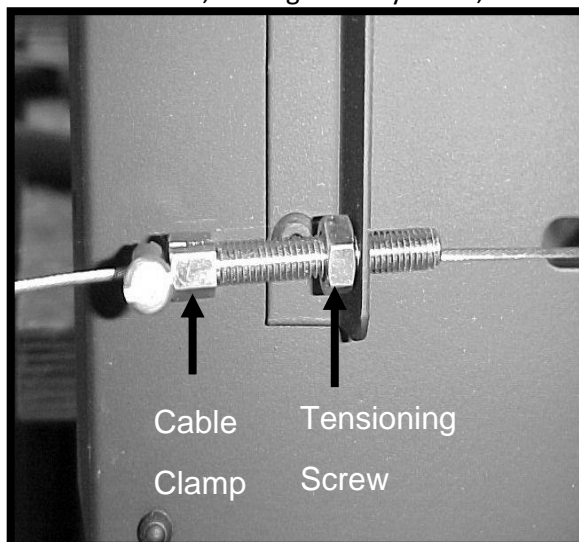

SECTION TEN Checking Operation of Fire (installation instructions)

CONNECTING SLIDE CONTROL LEVER

- Slide the control lever through handle guide bracket and fit the two m4 screws to secure the handle

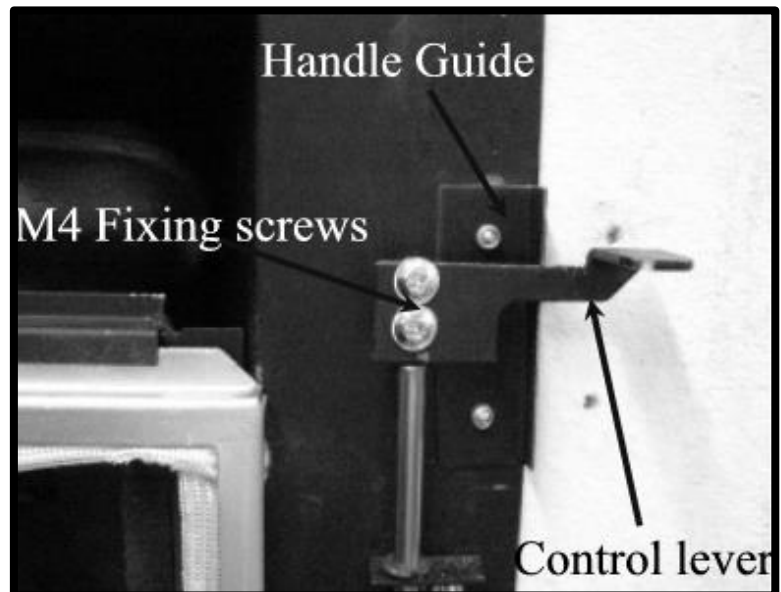

CONNECTING THE BATTERY

- Connect the battery to the boot lead which is located on the bottom left hand side of the appliance.
- Slide the battery within generator housing behind the retaining clip.

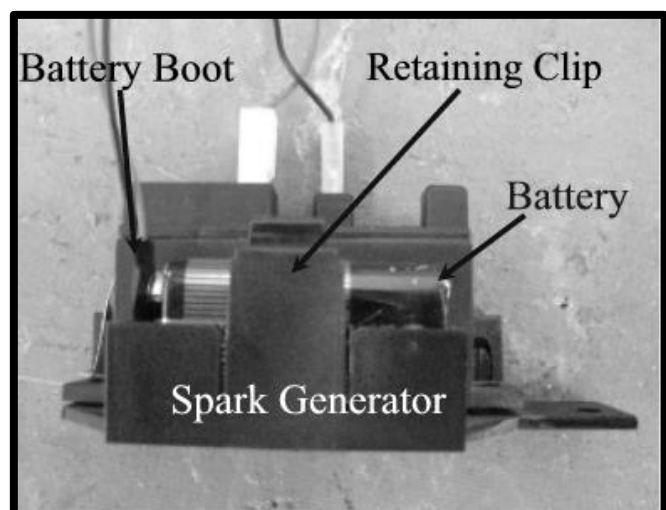

PLEASE FOLLOW THE BELOW GUIDANCE WHEN FITTING THE EDGE INSET FASCIA.

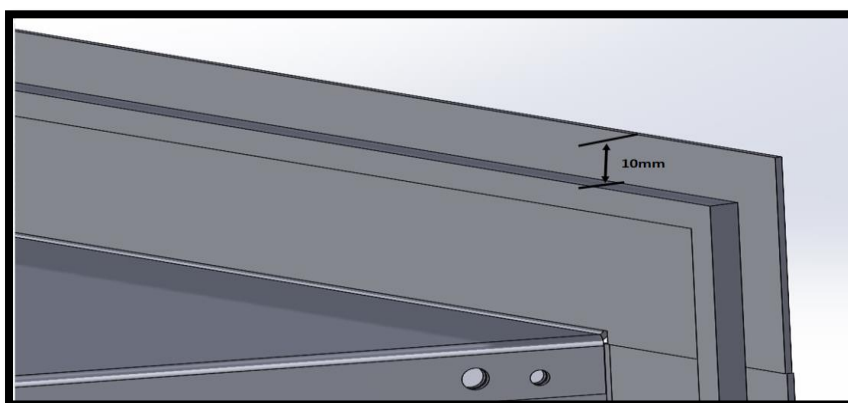

It is important to fit the installation seal leaving a 10mm gap between the top of the flange and the top face of the seal. **(Please note failure to follow this guidance will not allow the fascia to be fixed correctly)**

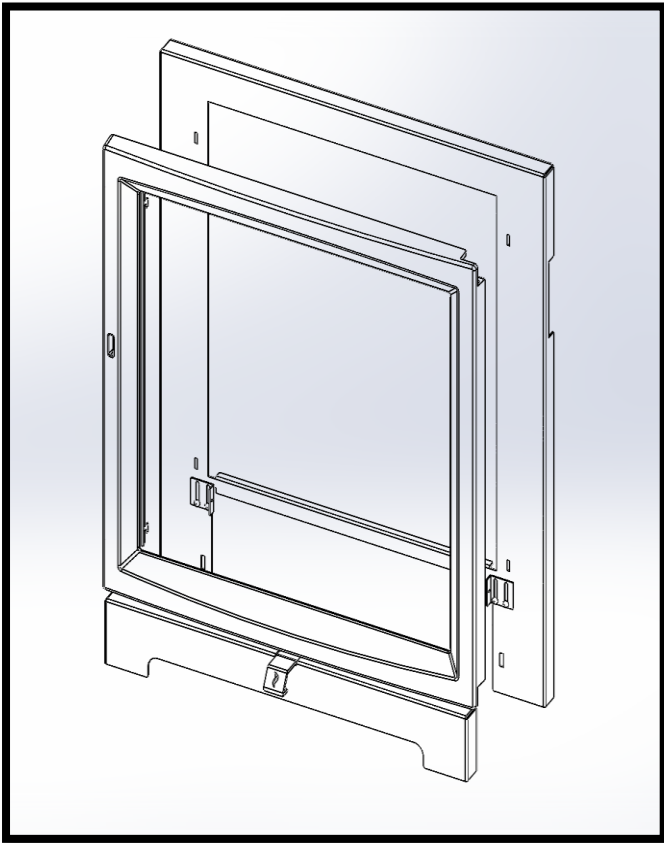

Taking great care remove the complete fascia from the packaging.
The door and ashpan are located onto the main frame by location lugs. Carefully lift off both assemblies away from the main frame body.

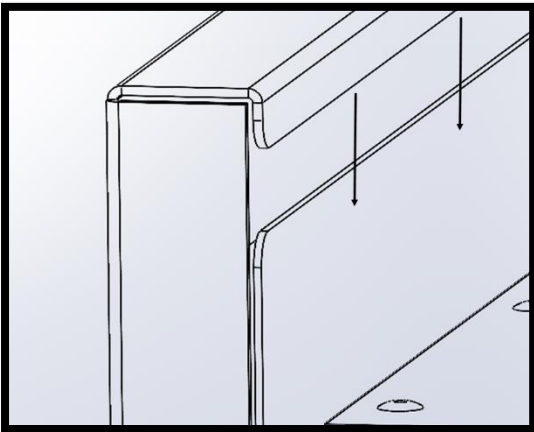

Offer the main frame up to the installed fire, slide the rear top edge of the fascia frame down in between the fire box flange and the fireplace back panel.

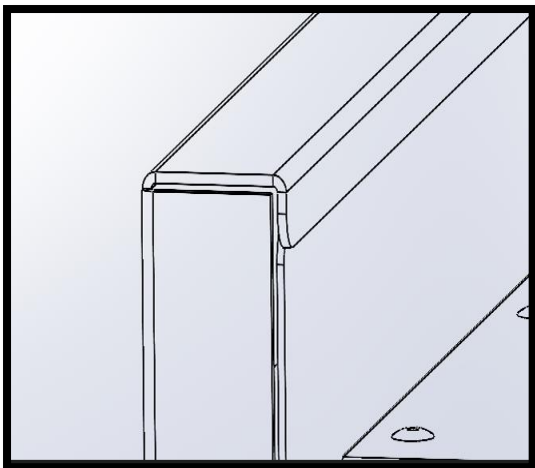

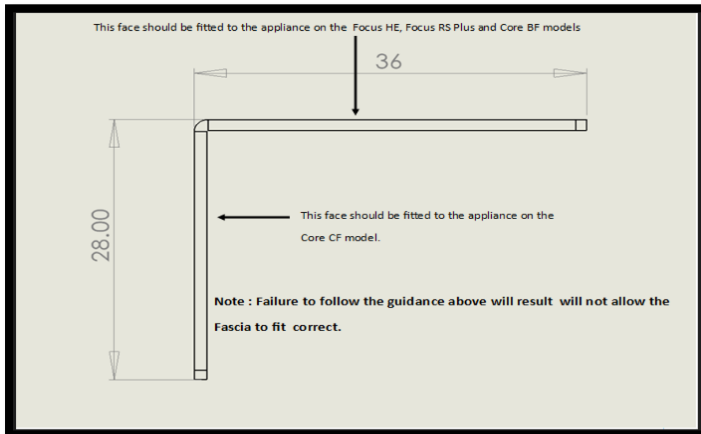

Within the fascia packaging are two adjustment brackets, two fixing screws and two M4 nuts. The adjustment brackets are design for use on various Paragon models. Please follow the instruction opposite to achieve the correct format for the model you are fitting.

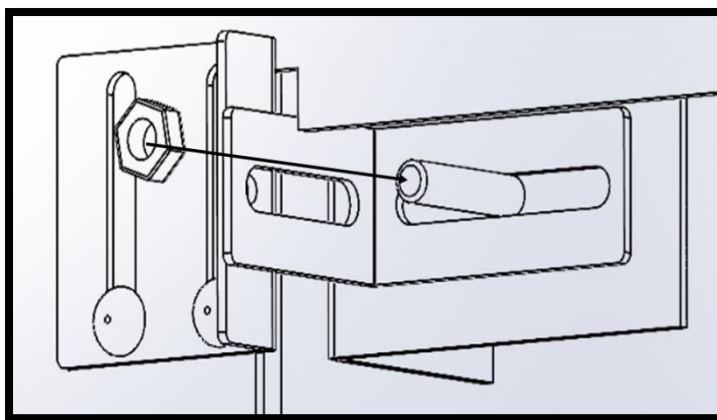

Below the fire tray assembly are two M4 stud left hand and right hand within the fire box assembly. Slide the adjustment brackets over the studs and fix using the M4 nut provided.

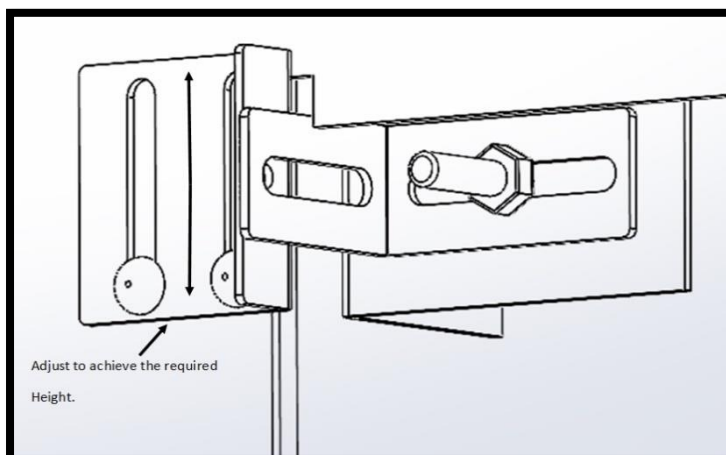

With the two adjustment brackets in position. Loosen the two screws holding the retaining bracket (on the main frame body) and move to the required height and tighten.

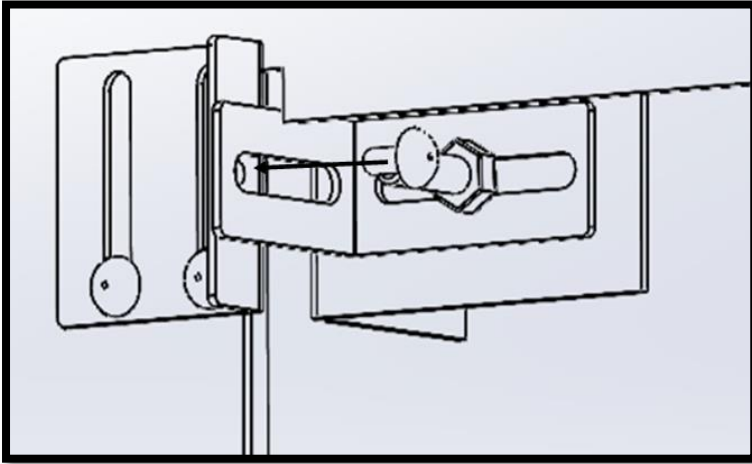

Fit the No6 screws to fix the fascia trim to the fire box assembly as shown in the picture opposite.

Re locate the door assembly and the ash pan assembly back on to the main frame body to complete the process.

POSITIONING REMOTE CONTROL EYE

Note: - The remote control eye should be fixed to the front of the control fascia using a self-adhesive clip.

In some instances (e.g. when an alternative fret or ash pan cover is used) it may be necessary to reposition the remote control eye, an alternative position is specified below.

- Position the remote control eye as shown with the front edge level with the ash pan cover.
- Secure in position with insulation tape as shown. Position the tape at the rear of the eye do not place any tape over the eye as this may cause receiving problems.
- Connect battery pack to appliance and insert the 6 AA batteries. Position the battery pack at the front on the left hand side.
- Reposition ash pan cover.
- Fit batteries (2 x AAA) battery (supplied) to remote control hand set (see Section 2).
- Check that a signal is being received by pointing the remote control hand set in the direction of the appliance and simultaneously press the buttons marked '●' and 'standby'. Continue to hold in these two buttons until a 'bleep' is heard (approximately 2-3 sec.). If no sound is heard check position of remote control eye.

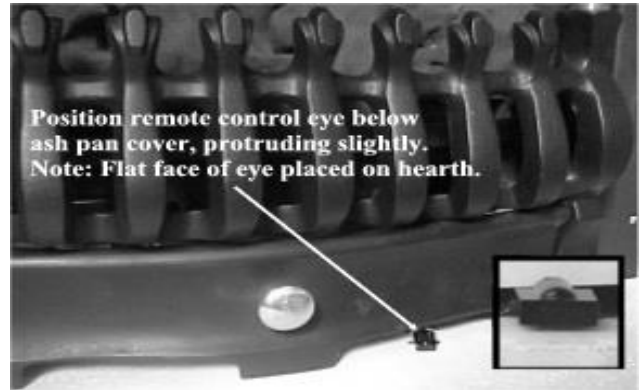

SECTION TEN Checking Operation of Fire (installation instructions)

CHECKING GAS SOUNDNESS

Batteries must be connected before proceeding with any soundness testing

- Turn on the gas supply to the appliance and check for soundness in accordance with current codes of practice.
- Turn off the gas supply at the external Isolation valve.
- Remove the pressure test point screw from the inlet elbow and connect the pressure gauge.
- Turn on the gas to the appliance at the Isolation valve.
- Light the appliance as described in section 2.
- Check the inlet pressure is 20mbar. +/- 1.0. or 37mbar +/- 1.0
- Turn off gas supply, at the isolation valve. Disconnect the pressure gauge and replace the pressure test point screw.
- Turn on the supply to the appliance and check the pressure test point for soundness with detection fluid.

LAY FUEL BED

Important: -

Refer to the Health & Safety Notice located on page 3 of this booklet before laying or replacing any refractory material.

In the event of replacing fuel bed components please use only the specified number of components as illustrated. Only use fuel bed component provided for this appliance. In the interest of safety and efficiency of your appliance when replacing the fuel bed it is essential that the existing fuel bed be removed and the new components are replaced correctly as a complete set.

Lay fuel bed as described under Users Section.

Warning:

It is important that the fuel bed components are positioned as shown in these instructions.

If the fuel bed components are not positioned correctly this may result in damage to the glass.

REFIT GLASS PANEL

- Refit glass panel. Prior to replacing the glass panel it may necessary to adjust the seal around the glass to ensure it is not seen when the decorative trim or fascia is fitted.

CHECKING FOR COMBUSTION PRODUCTS CLEARENCE

IMPORTANT:-The smoke test must be carried out with the fire starting from cold.

- Light the fire and leave at maximum input.
- Close all the doors and windows.
- After five minutes fit the smoke match in a holder and position as illustrated with the head of the match just inside the test opening.
- Run the match along the top edge **ALL SMOKE** must be drawn into the test opening if the clearance is satisfactory.
- If spillage occurs wait a further five minutes and repeat the test.
- Repeat the test with doors open and with any extractor fans in other rooms in operation.

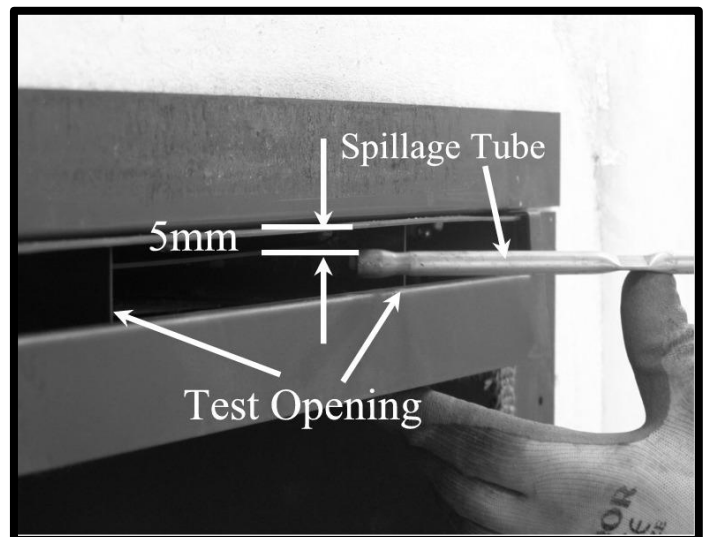

If spillage still occurs the factory fitted restrictor plate needs to be removed from the rear outlet of the firebox. Remove the two torx screws retaining the plate and remove.

Please note that removing the plate without conducting a spillage test can result in pilot outing under windy conditions.

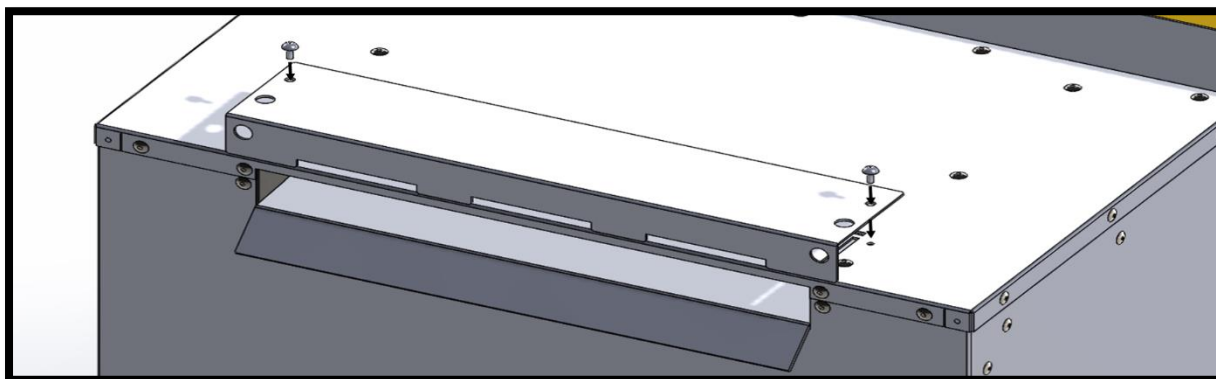

With the plate removed and if spillage is detected the cause must be discovered and the fault corrected. If the fault cannot be corrected, disconnect the fire from the gas supply and seek expert advice. Spillage can be caused by a restriction in the flue, down draught, or insufficient ventilation into the room where the fire is installed.

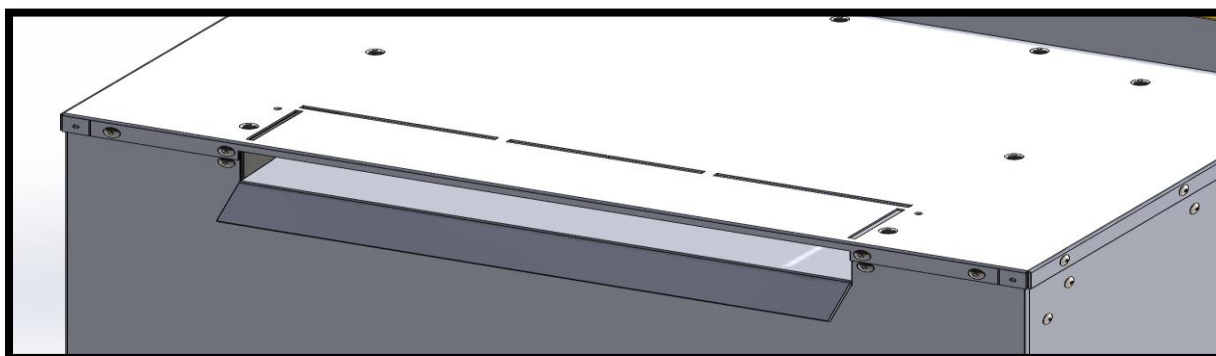

If the appliance is experiencing outing due to the flue having excessive flue draw, then the full restrictor may need to be fitted to combat this flue draw. This is provided in the box with the fire.

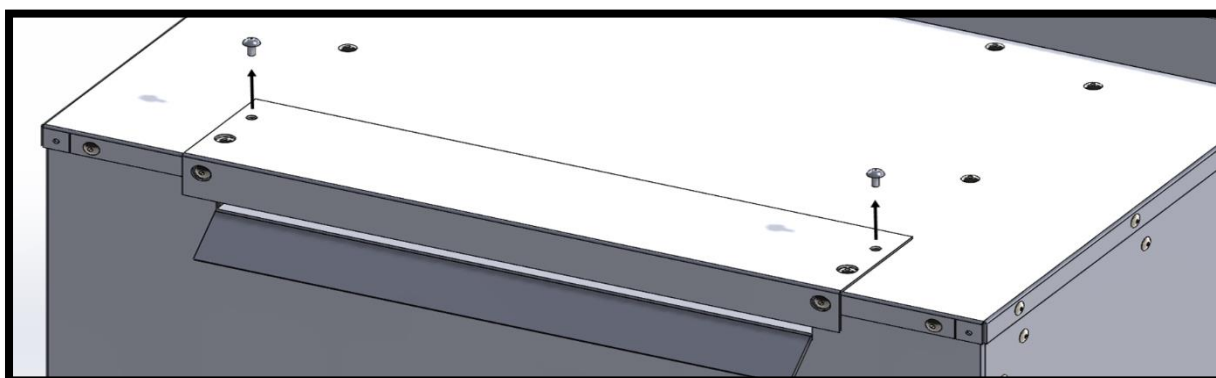

FIT STANDARD FIRE TRIM, FRET & FASCIA

- Fit the fire with the magnetic strips placed on the vertical side flange of the box. Avoid placing magnets along the top section of the trim.
- For four-sided trim fitting see instructions supplied with trim.
- Offer the decorative trim up squarely and centrally and push into position.
- To remove the decorative trim, simply pull away from the magnetic strips.
- Fit the fire fret by standing on the hearth OR plinth in front of the fire.

ADVISE CUSTOMER THAT:

- The glass front of this fire acts as a dress guard, conforming to BS 1945 (1997) and satisfies the heating appliance regulations (1991) however; a fireguard conforming to BS6539 (1997) must be used to protect young children, the elderly, or infirm.
- The curing effect of heating the coals and other refractory components will cause an initial odour. This is due to the starch used in the manufacturing process and is non-toxic.
- The fret is hand cast and some minor imperfections may be found on the surface.
- Any debris should be cleaned from the appliance. A vacuum cleaner can be used but only after all the loose coals have been removed.
- The appliance should be serviced annually by a competent person in accordance with these instructions and the appliance checked for spillage in accordance with the method detailed in these instructions.
- Demonstrate the lighting and extinguishing procedures to the user and the removal and refitting of the trim fret and glass panel for cleaning. Refer to the user section of this booklet.
- If ventilation is fitted for any reason, it must be checked regularly to ensure freedom from obstructions.
- **Hand these instructions over to the user.**
- Please be aware that the non-reflective glass may in some lights and from some angles have a blue tinge to it this is perfectly normal. Also be aware that if the glass liners are fitted in the fire with the non-reflective glass you will still have a reflection in the glass liners.

SECTION ELEVEN Maintenance Instructions (maintenance instructions)

GENERAL

- Servicing should be carried out annually by a competent person such as a GAS SAFE-registered person in accordance with the relevant regulations, to ensure the safe and correct operation of the appliance.
- Before commencing any service or replacement of parts, turn off the gas supply to the fire. After servicing check for gas soundness.
- When ordering spare parts please quote appliance name and serial number, these can be found on the data badge, which is located on the base of the appliance behind.
- At least once a year check for debris in the catchment area behind the fire and in the flue way.
- If soot has accumulated checks to establish cause rectify and clean flue or chimney accordingly.

PILOT LINTING

It will be necessary to remove the burner assembly from the fire to clean the pilot head & pilot aeration hole.

Check pilot aeration holes for linting, use a vacuum cleaner nozzle taking care not to damage the pilot head.

REPLACEMENT OF GAS CONTROL AND OR THE SPARK GENERATOR

1. Turn off the gas supply by isolating cock.
2. Lift away carefully fire fret trim and fascia.
3. Remove glass assembly.
4. Lift away carefully all loose fuel bed components.
5. Disconnect gas supply from inlet elbow of appliance.
6. Undo and remove two lower screws from fixing plate at front of appliance.
7. Undo and remove the 2 screws securing the tray to the fire box.
8. Undo the screw at the lower end of the slide control lever and separate it from the link (if applicable)
9. Slide the appliance engine from the main casing.
10. Remove the ignition lead carefully from the pilot and the two switch leads from the gas valve ignition switch on the spindle of the gas control (if applicable)
11. Remove the spark generator by removing the retaining nut. (if applicable)
12. Disconnect the three compression gas connections from the gas control.
13. Undo the thermocouple connection from the rear of the gas control tap.
14. Undo the screw in the centre of the gas control spindle and remove from linkage (if applicable)
15. Undo and remove the two screws securing the gas control tap to assembly.
16. Service or replace gas control tap as necessary.
17. Re-assemble the in reverse order.
18. Turn on the gas supply, check for soundness and re commission appliance.

REPLACEMENT OF INJECTOR

- Follow the burner tray removal sequence.
- Remove the 2 screws retaining the burner and remove.
- Undo the compression nut on the supply pipe.
- Unscrew the locking nut holding the injector on the chassis.
- Clean or replace the injector.

NOTE: -Do not use a wire or a drill to clean out holes. Injectors are different sizes. Refer to the appliance data section for details.

- Re-assemble in reverse order.

REPLACEMENT OF OXY-PILOT ASSEMBLY

NOTE: If the pilot assembly is replaced it must be replaced by an identical unit from the same manufacturer and replaced as a complete unit.

- Undo the compression nut on the supply pipe at the pilot.
- Carefully pull off the ignition lead.
- Disconnect the thermocouple at the end of the main control valve.
- Remove the 2 screws holding the pilot to the chassis
- Carefully remove the oxy-pilot.
- Re-assemble in reverse order.

REPLACEMENT OF CONTROL UNIT (EDB)





1. Repeat operations for removal of gas control.
2. Disconnect leads from control unit and remove the bolt.
3. Re-assemble in the reverse order.





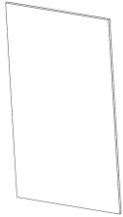

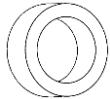
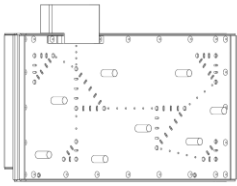
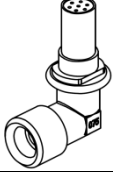
Turn on the gas supply, check for gas soundness and recommission appliance

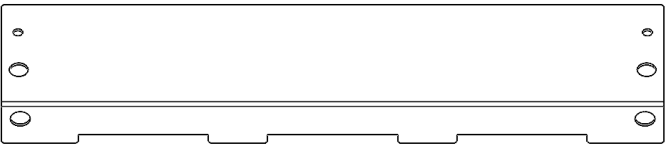
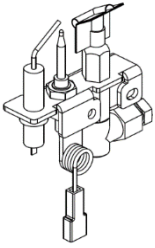
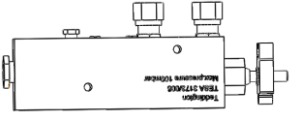
FLUE CHECK

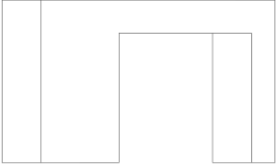
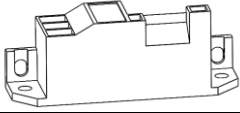
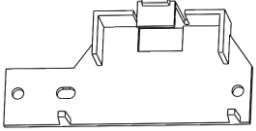
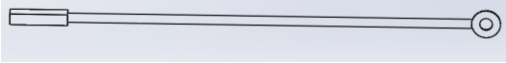
- Remove the fire from the opening: - Reversing fitting instructions, but first remove fret, trim, glass panel and coals.
- Examine flue and rectify as necessary.
- Replace the fire, referring to fitting instructions.

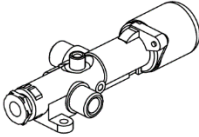
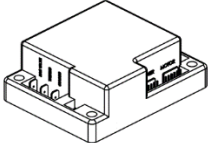
Short Spares List

Image	Description	Part number
	Glass Side Liner	Glass: 8580 Ceramic: 8683
	Glass rear liner	Glass: 8579 Ceramic: 8684
	Top liner	8581
	Nylon spacer	4526
	Burner	NG: 7919 LPG: 8336
	Injector 360A LPG: stamped 116	NG: 6226 LPG: 2222
	Full restrictor plate	7924
	Restrictor plate	9510
Slide Control Parts		
	Oxy pilot 2550 NG LPG: 9221	6952 LPG: 1059
	Slide valve	NG: 2542 LPG: 2543

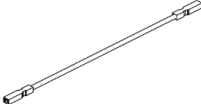
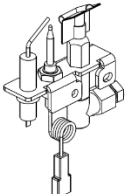
	<p>Silencer</p>	<p>NG: 7937 LPG: no silencer</p>
	<p>Ignitor scat</p>	<p>8877</p>
	<p>Scat battery holder</p>	<p>8878</p>
	<p>Scat earth lead</p>	<p>8880</p>
	<p>Scat Battery Lead</p>	<p>8879</p>
	<p>Scat microswitch leads</p>	<p>8881</p>
<p>Remote Control Parts</p>		
	<p>Valve</p>	<p>6590</p>
	<p>EDB</p>	<p>6592</p>
	<p>Handset</p>	<p>6598</p>
	<p>Receiver</p>	<p>6595</p>
	<p>Battery lead</p>	<p>6596</p>
	<p>Ignition lead</p>	<p>6646</p>
	<p>Oxy pilot 2900</p>	<p>7280</p>

	Earth lead	6776
---	------------	------

Register your appliance online today to active your warranty



GAS FIRE COMMISSIONING CHECKLIST

This Commissioning Checklist is to be completed in full by the competent person who commissioned the gas fire as a means of demonstrating compliance with the appropriate Building Regulations and then handed to the customer to keep for future reference.

Failure to install and commission according to the manufacturer's instructions and complete this Benchmark Commissioning Checklist will invalidate the warranty. This does not affect the customer's statutory rights.

Site Requirements	Yes	N/A
Was the chimney checked to ensure it only serves one flue/fire, has no obstructions and is continuous?		
Has any debris at the base of the chimney been removed?		
For brick chimney installations is there enough depth for 12 litres of debris, or precast flues 2 litres of debris? (see instructions for debris gap details)		
Have damper and register plates been removed or locked in the fully open position ensuring correct size of flue is maintained?		
If previously used for solid fuel has the chimney been thoroughly swept?		
If the chimney is pre-cast has the inside of the flue been checked for extruded cement / sealant which must be removed?		
Has the fire place been checked for under-floor air supply which must be sealed off?		
Has the chimney been inspected prior to fitting the gas fire to ensure that it is in good condition?		
Has the structure of the chimney been checked for leakage using a smoke pellet test? (See BS5440-1 for details).		
Ventilation		
Does the installation require any additional ventilation requirements as detailed in the manufacturer's instructions?		
Hearth Requirements- where fitted		
Is the hearth constructed from non -combustible material?		
Is the hearth a minimum of 12mm thick with a minimum floor to top surface of 50mm?(BS5871) or as per manufacturer's instructions?		
Is the hearth for open fronted fires a minimum of 760mm wide and has 300mm projecting from the fire opening (BS6871) or to manufacturer's instructions?		
Mounting height (where applicable) has the fire been installed to the correct mounting height- as per manufacturer's instructions?		
Firebox and Fuel Bed		
Has the fuel bed, coals, pebbles etc. been fitted to manufacturer's instructions?		
Gas Supply		
Has an isolation tap/restrictor inlet elbow been fitted for servicing?		
Has the gas supply been thoroughly purged prior to connection to remove any debris?		
Has a gas tightness test been completed prior to breaking into the gas supply and following completion of installation?(IGEM/UP/1B)		
Record burner gas pressure reading? If only the supply pressure is available a gas rate must be undertaken.(GSIUR REG26/9C)		
Record dynamic inlet gas pressure (working pressure) reading (all gas appliances running)		
Spillage test		
Installation passes smoke match test with any extractor fans turned on (see manufacturer's instructions)		
Installation		
Has the gas fire been installed and commissioned in accordance with manufacturer's instructions?		
Has the fire been installed with the correct clearance to combustible materials, as per manufacturer's instructions?		
The operation of the appliance and controls have been demonstrated to the customer including battery replacement where applicable?		
The manufacturer's literature, including Benchmark Checklist and Service record has been explained and left with the customer?		
Has the appliance been registered with the Local Authority as detailed on the Gas Safe web site and is a legal requirement and forms part of the warranty?		
Customer's Signature: (To confirm satisfactory demonstration and receipt of manufacturer's literature)	Commissioning Engineer's Signature:	

*All installations in England and Wales must be notified to be Local Authority Building Control (LABC) either directly or through a Competent Persons Scheme. A Building Regulations Compliance Certificate will then be issued to the customer.

SERVICE RECORD

It is essential that your gas fire is serviced regularly and that the appropriate Service Interval Record is completed. Service Provider

Before completing the appropriate Service Record below, please ensure you have carried out the service as described in the manufacturer's instructions. Always use the manufacturer's specified spare part when replacing controls.

























SERVICE 01	Date:
Engineer name:	
Company name:	
Telephone No:	
Gas safe register No:	
Comments:	
Signature	

SERVICE 02	Date:
Engineer name:	
Company name:	
Telephone No:	
Gas safe register No:	
Comments:	
Signature	

SERVICE 03	Date:
Engineer name:	
Company name:	
Telephone No:	
Gas safe register No:	
Comments:	
Signature	

SERVICE 04	Date:
Engineer name:	
Company name:	
Telephone No:	
Gas safe register No:	
Comments:	
Signature	

SERVICE 05	Date:
Engineer name:	
Company name:	
Telephone No:	
Gas safe register No:	
Comments:	
Signature	

Product ID Label	Serial No Prefix	Product ID Label	Serial No Prefix
Slide control A-0720	SN (NG)		
Slide control with Glass liners	UT (NG)		SP (NG)
Slide control with ceramic liners	UT (NG)	Remote A-0721	TK (LPG)
Slide Control (LPG)A-0807	TJ (LPG)	Remote A-0808	
Burner Tray / Box Assembly		Burner Tray / Box Assembly	
Restrictor Elbow (2194) 		Restrictor Elbow 2189 	
Core Log Set		Core Log Set	
Glow (6844)		Glow (6844)	
Slide Control Handle  Fixing Screws x 2 		Remote Quick Reference card (6713)	
Fret Plate 		Fret Plate 	
Battery (9V) 		Remote Control Handset 	
Handle Cover (4570)		Battery Holder 	
Magnet (4 x 3048) 		Magnet (4 x 3048) 	
Foam Sealing (4904) 		Foam Sealing (4904) 	
Wire Fixing Kit (A-0474)   QTY 4  QTY 4  QTY 4  QTY 4		Wire Fixing Kit (A-0474)   QTY 4  QTY 4  QTY 4  QTY 4	
7mm Spinner (5435) 		7mm Spinner (5435) 	
Restrictor plate		Restrictor plate	
Connection Pipe (5549)		AAA Battery (2)	
Glass panel (7912)		Glass panel (7912)	
Data Badge and spillage label (Located on the base)		Data Badge and spillage label (Located on the base)	
Inspector			
Serial Number:			