

# Owner's Manual

INCLUDES

User, Maintenance, Service, and Installation  
Instructions



## Core BF Remote Control



Keep this booklet for service log and future reference.

### IMPORTANT



This appliance is guaranteed for 12 months subject to conditions. The 5 year extended parts warranty will only be valid if the annual service recommended in this manual has been completed and appliance has been registered online.

## Contents

EXTENDED FIVE YEAR PARTS WARRANTY .....	2
Benchmark Scheme .....	3
<b>SECTION ONE Important Information (user instructions).....</b>	<b>5</b>
<b>SECTION TWO Introduction (user instructions) .....</b>	<b>7</b>
<b>SECTION THREE Operation (user instructions) .....</b>	<b>7</b>
<b>Low Battery Indication (Handset) .....</b>	<b>8</b>
<b>SECTION FOUR Cleaning &amp; Fuel Bed Laying Continued (user instructions) .....</b>	<b>9</b>
<b>SECTION FIVE Replacement Parts (user instructions) .....</b>	<b>17</b>
<b>SECTION SIX Appliance Data (installation instructions).....</b>	<b>17</b>
<b>SECTION SEVEN Regulations and Warnings(installation instructions) .....</b>	<b>18</b>
<b>SECTION EIGHT Siting the Appliance (installation instructions).....</b>	<b>20</b>
<b>SECTION NINE Preparing the Appliance for Installation (installation instructions) .....</b>	<b>22</b>
<b>SECTION TEN Power Lead Routing.....</b>	<b>22</b>
<b>SECTION ELEVEN To Install the Appliance (installation instructions).....</b>	<b>23</b>
<b>SECTION TWELVE Assemble the Appliance (installation instructions) .....</b>	<b>28</b>
<b>SECTION THIRTEEN Check Operation of Fire (installation instructions) .....</b>	<b>28</b>
<b>SECTION FOURTEEN Instruct and Advise the Customer (installation instructions) .....</b>	<b>28</b>
<b>SECTION FIFTEEN Maintenance Instructions (maintenance instructions) .....</b>	<b>29</b>
<b>Shorts Spares list .....</b>	<b>31</b>
<b>BALANCED FLUE GAS FIRE COMMISSIONING CHECKLIST .....</b>	<b>36</b>
<b>SERVICE RECORD.....</b>	<b>37</b>



## EXTENDED FIVE YEAR PARTS WARRANTY

In order to validate your extended 5 years parts warranty please read the Benchmark Scheme on the opposite page and ensure your installer has filled in the appropriate checklist.

**This in no way reduces your statutory rights.**

Your warranty commences from the date of purchase, and you must retain your receipt or invoice as proof of a purchase date.

THIS EXTENDED WARRANTY SPECIFICALLY EXCLUDES GLASS AND SOFT REFRACTORY COMPONENTS, THE BULB AND ANY BATTERIES.

### Terms and Conditions

1. The appliance must be installed by a GAS SAFE registered person.
2. The appliance must be used in accordance with the user's instructions.
3. The appliance must be serviced annually by a GAS SAFE registered person.
4. The benchmark and service log must be correctly filled out and the record of annual services must be up to date and supported by receipts in each case.
5. This warranty is not transferable and relates to the original installation only.
6. The appliance has not been subjected to misuse or accident or been modified or repaired by any person other than the authorised employee or authorised representative of Charlton and Jenrick Ltd.
7. The registration form must be returned within 1 month of purchase.

**Technical Help Desk 01952 200 444**



## Benchmark Scheme

Charlton and Jenrick Ltd is a licensed member of the Benchmark Scheme which aims to improve the standards of installation and commissioning of domestic heating and hot water systems in the UK and to encourage regular servicing to optimise safety, efficiency and performance. Benchmark is managed and promoted by the Heating and Hotwater Industry Council. For more information and the full code of practice please visit [www.centralheating.co.uk](http://www.centralheating.co.uk)

Please ensure that the installer has fully completed the Benchmark Checklist on the inside back pages of the installation instructions supplied with the product and that you have signed it to say that you have received a full and clear explanation of its operation. The installer is legally required to complete a commissioning checklist as a means of complying with the appropriate Building Regulations (England and Wales).

All installations must be notified to Local Area Building Control either directly or through a Competent Persons Scheme. A Building Regulations Compliance Certificate will then be issued to the customer who should, on receipt, write the Notification Number on the Benchmark Checklist.

This product should be serviced regularly to optimise its safety, efficiency, and performance. The service engineer should complete the relevant Service Record on the Benchmark Checklist after each service.

The Benchmark Checklist will be required in the event of any warranty.

It is a requirement that the gas fire is installed and commissioned to the manufacturer's instructions and the data fields on the commissioning checklist completed in full.

To instigate the guarantee, the gas fire needs to be registered with the manufacturer within one month of the installation.

To maintain the guarantee, it is essential that the gas fire is serviced annually by a Gas Safe registered engineer. The service details should be recorded on the Benchmark Service Interval Record and left with the householder.

## **Important**

For future reference, we suggest you record the following details here, and keep the receipt as proof of purchase. This information maybe asked for when you contact the helpdesk.

<b>MODEL:</b>	<b>Paragon Core BF Remote Control</b>	<b>Serial No.</b>	
---------------	---------------------------------------	-------------------	--

This information can be found on the label attached to the packaging and on the data badge, which is located on the base of the appliance behind the control cover.

<b>Retailer Name:</b>	
<b>Address:</b>	
<b>Date Of Purchase:</b>	

## **Installer information required to register for the extended warranty**

<b>Name:</b>	
<b>Date of installation:</b>	
<b>Gas safe number:</b>	

## SECTION ONE Important Information (user instructions)

### Consumer protection information

As manufacturers and suppliers of heating products, we take every care, as far as is reasonably practicable, that these products are so designed and constructed as to meet the general safety requirement when properly used and installed. To this end, our products are thoroughly tested and examined before despatch.

**IMPORTANT NOTICE:** Any alteration that is not approved by the appliance manufacturer could invalidate the approval of the appliance, operation of the warranty and could affect your statutory rights.

### Health and safety notice

#### Important

This appliance could contain some of the materials, indicated below, that could be interpreted as being injurious to health and safety. It is the users / installers responsibility to ensure that the necessary personal protective clothing is worn when handling these materials, see below for information.

**Artificial Fuels, Mineral Wool, Insulation Material, Refractory/Ceramic Fibres, Glass Yarn** - *may be harmful if inhaled, may be irritating to skin, eyes, nose and throat.*

**When handling** *avoid inhaling and contact with skin or eyes. Use disposable gloves, facemasks, and eye protection. After handling wash hands and other exposed parts. If a vacuum is used for cleaning the coals or cleaning after servicing / installation it is recommended that it be of the type fitted with a HEPA filter.*

**Disposal of refractory/ceramic materials.** *To keep dust to a minimum these materials should be securely wrapped in polythene and be clearly labelled 'RCF waste'. These materials are not classified as 'hazardous waste' and should be disposed of at a site licensed for the disposal of industrial waste.*

- The PARAGON CORE BF is an inset room sealed decorative fuel-effect gas appliance.
- The PARAGON CORE BF is available in **Natural Gas (G20 @ 20 mbar Only)**. The marking (**G20 for natural gas**) on the packaging and the data badge specifies the gas for which the appliance has been factory set. **Note: These appliances should only be used on the appropriate gas specified. They are not suitable for conversion from one gas to the other.**
- Failure to install appliance correctly could lead to prosecution.
- In GB (Great Britain), the appliance must be installed and serviced by a competent person i.e. Gas Safe-registered, in accordance with the GAS SAFETY (INSTALLATION AND USE) REGULATIONS, The Building Regulations (or The Building Regulations (Scotland) or The Building Regulations) and The Current I.E.E. Wiring Regulations, if appropriate.
- The PARAGON CORE BF does not require a chimney but **must be** installed against an outside wall.
- It is important that the flue terminal is regularly always checked and kept clear.
- If the terminal is accessible to people (i.e. less than 2m above a walkway, balcony etc.) the terminal guard must be fitted to prevent access to the flue outlet, which becomes hot when the fire is in use.
- All combustible material must be removed from behind the fire and fire trim.

- As the PARAGON CORE BF is a room sealed appliance (i.e. air for the combustion process is taken from outside the room) no purpose built ventilation is required.
- The PARAGON CORE BF is designed and tested to meet the requirements of the European Standard EN 613.
- The PARAGON FOCUS RS REMOTE is powered by mains electricity via pre-wired transformer plus supply cord.
- The standby facility switches off the mains gas supply to the appliance, but the pilot remains alight.
- Although the PARAGON CORE BF is fitted with a glass front which acts as a dress guard it is strongly recommended that a fireguard should be used for the protection of children, the elderly or infirm. Fireguards should conform to B. S. 6539 (1984) (Fireguards for use with solid fuel appliance).
- The slot located at the top of the PARAGON CORE BF are the hot air outlets and as such must not be obstructed in any way (particularly by clothes or other combustibles). In addition, the base of the appliance should not be obstructed by such items as this may adversely affect the performance of the appliance.
- Care should be taken to prevent any damage being caused to surrounding soft furnishings or decoration. Many wall coverings may become discoloured if placed too close to the appliance, it is strongly recommended that any proposed wall covering intended for use immediately above the appliance should be tested in the hottest position (immediately above) first. Run the fire on high over a few days
- The first time you light your new appliance a smell may occur due to its new condition. This is quite normal and will soon disappear after a few hours use at maximum setting (open a window until the smell disappears).
- The appliance **MUST NOT** be used if the glass panel is not correctly fitted or if this panel is cracked or broken.
- Any debris should be cleaned from the appliance. A vacuum cleaner can be used but only after all the loose coals have been removed.
- ***Prior to removing or cleaning the fuel bed components refer to the 'Health and Safety Notice' located on page 5 of this booklet.***
- The appliance should be serviced annually by a competent person i.e. a **Gas Safe registered engineer** in accordance with these instructions.
- The glass or any part of the appliance **MUST NOT** be cleaned or wiped whilst the appliance is **HOT**, to do so could be dangerous and may damage the paintwork of the appliance.
- The cast fire front or Fascia casing **MUST BE** positioned in front of the fire whilst it is burning.
- Where a fire front (fret) is used with this appliance it must conform to the following:
  - It must be made from non-combustible material.
  - Its general construction should enable it to stand firmly across the full width of the burner.
  - The design of the fire front (fret) must have a removable ashtray cover (lower section).
  - The ash tray cover must have cut outs and or holes which provide ventilation to the underside of the burner.
  - The effective area of ventilation through the ash tray cover must be greater than 1365mm<sup>2</sup> (2.12 sq. ins.)

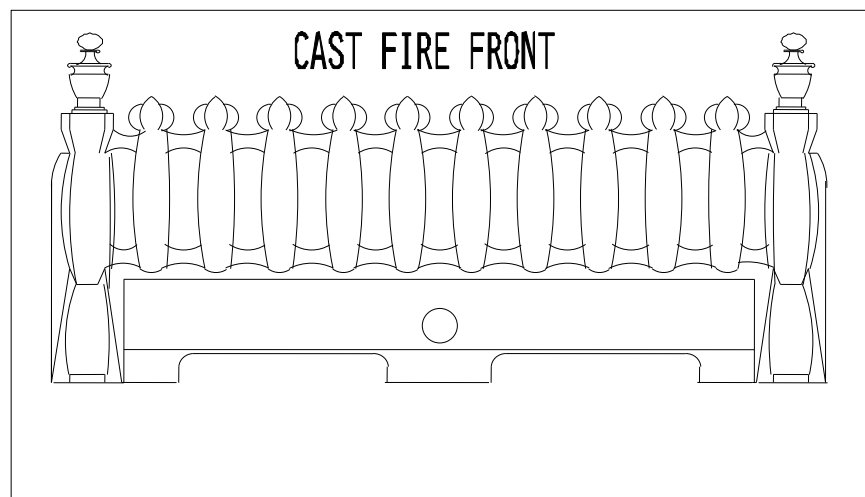

## SECTION TWO Introduction (user instructions)

- The PARAGON CORE BF is an inset room sealed live fuel-effect gas appliance designed for use in locations that do not have a conventional chimney. The appliance must be installed against an outside wall because the air to support combustion is taken from the outside and the products of combustion are expelled to the outside.
- The appliance incorporates a safety device in the form of a FLAME SUPERVISION DEVICE, which constantly monitors the flame and will cause the gas to be switched off if the flames are extinguished for any reason. **THIS DEVICE MUST NOT BE OVERRIDDEN.** If this situation occurs on a regular basis have the appliance checked by a qualified engineer. The problem may be due to a blocked or restricted flue.
- Before removing the fret, trim, glass, or fuel bed for cleaning the fire should be turned off and left to cool down.
- **NOTE:** In use some discoloration of the components will take place in the combustion box, this is normal, but can be kept to a minimum if the logs are placed correctly (i.e. after cleaning). See Section 4.
- As with all heating appliances certain areas (Working Surfaces) become very hot when the appliance is in use. Only the control handle should be touched when the fire is being used.
- Like all appliances incorporating an aerated burner a low frequency noise may be heard, this may be more noticeable on the low setting. To obtain an authentic fire sound, a noise maybe noticeable from the burner.

## SECTION THREE Operation (user instructions)

Do not use this appliance without the glass panel fitted, or if this panel is cracked or broken.

**WARNING:** If the burner or pilot is extinguished for any reason, do not attempt to re-light the pilot for at least three minutes.



**WARNING:** If the burner or pilot is extinguished for any reason, do not attempt to re-light the pilot for at least three minutes.

**Before attempting to operate the appliance check that nothing has been placed in front of the appliance.**

**To light the appliance using the remote handset:**

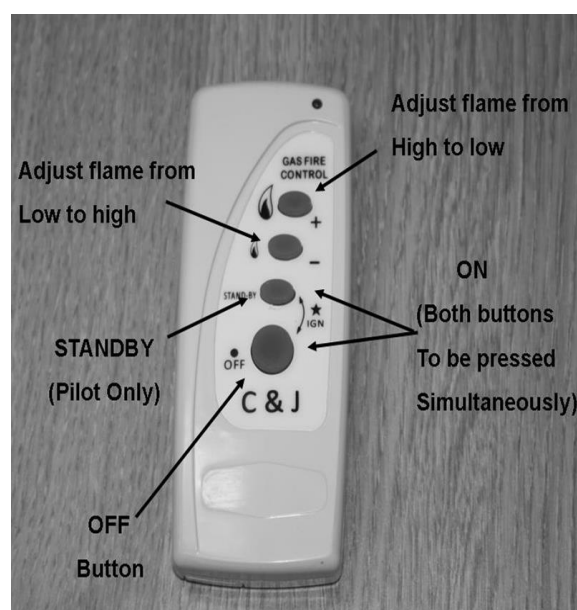
- Point the remote-control handset in the direction of the appliance and simultaneously press the buttons marked 'off' and 'standby'. Continue to hold in these two buttons until a 'bleep' is heard (approximately 2-3 sec.) and then release these buttons. The appliance will automatically go through the ignition sequence and the pilot should ignite. Once the pilot is alight the appliance will automatically go to the high setting (approximately 20-25sec). If the ignitor stops sparking and the pilot fails to light, repeat this procedure.



- The appliance can be adjusted up or down by pressing the appropriate button  (low setting) or  (high setting). There are 5 heat settings, and the fire will give a double bleep when the maximum or minimum heat setting is reached. To switch off the appliance press the OFF  button or if the appliance is to be switch off

for a short period it is recommended that the 'standby' button be used. This switches the main burner off but leaves the pilot on.

- C. The appliance can be switched off without using the handset by disconnecting the power lead. When the lead is removed there will be a delay (up to 3minutes) after which double bleeps may be heard and shortly after the appliance will extinguish. Ensure that the lead is reconnected once the fire has been extinguished. The appliance cannot be operated without the use of the handset. If the fire fails to light or extinguishes for any reason, it will be necessary to re-set the fire. This can be done by pressing the off ● button then following the normal lighting procedure.

**NOTE: If the fire is extinguished for any reason wait 3 minutes before relighting.**

**Note: if repeated delayed ignition is experienced during start-up, it is recommended that the appliance is checked by a gas safe engineer**

### **Low Battery Indication (Handset)**

If while pressing any of the buttons on the remote handset the low battery indicator lamp either stops flashing or appreciably slows then the batteries should be changed.

### **To Replace Batteries In Handset (AAA 1.5 v Ir3 X2)**

Remove the cover from the rear of the handset and fit replacement batteries. Take note of the orientation of the batteries as shown on the base of the battery compartment.

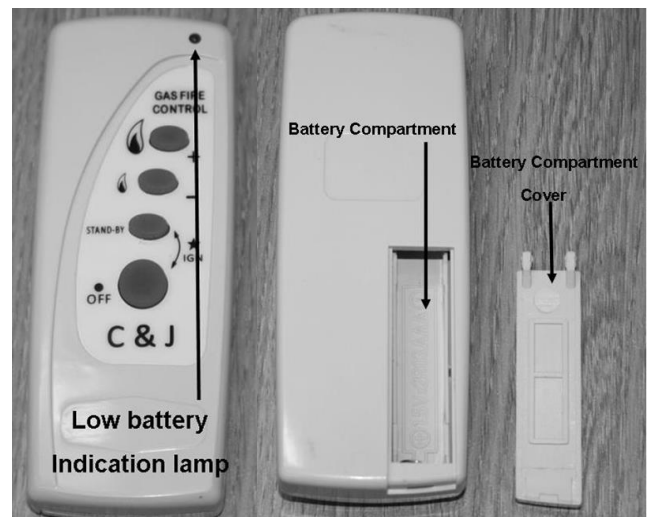

### **SECTION FOUR Cleaning & Fuel Bed Laying (user instructions)**

Warning: -Before you clean any part of the appliance ensure that the appliance is switched off and cold.

### **CLEANING: DECORATIVE TRIM**

- The Decorative finish of the trim is coated with a high temperature lacquer, it should be wiped with a soft, clean, dry, cloth only.
- The trim should be removed for cleaning. The fret should be removed before removing the trim, which is held in place by four magnets.

### **CLEANING: BLACK PAINTED SURFACES**

- These surfaces should be dusted regularly, and any marks removed with a soft cloth.
- Abrasive or chemical cleaner should never be used.

### **CLEANING: GLASS PANEL**

From time to time, it may be necessary to clean the glass panel.



We recommend you use a Ceramic Hob Cleaner (brands such as **HOB BRITE** and **VITRO CLEAN** have been found to be acceptable) these are available from most leading Supermarkets.

**Follow the Instructions on the Hob Cleaner Bottle.**

Remove the glass panel as follows:

- Remove ash pan cover and fret if fitted.
- Remove decorative trim (held in place with four magnets) or fascia.
- Remove the 2 nuts that hold the fret cover on and remove fret cover. Push the canopy upwards to disengage the hooks.
- Slacken but **do not remove** the 4 nuts securing the glass frame.
- Remove the 2 nuts located on the bottom of the glass frame. **Note:** when it is replaced ensure the glass is central and that all the four studs pass through the slots in the glass frame.
- While supporting the glass panel, remove the 2 nuts securing the sides of the glass frame, remove the glass frame and slide it out gently.
- Lay the glass panel down on a flat working surface on top of an old, opened newspaper with the side to be cleaned uppermost.

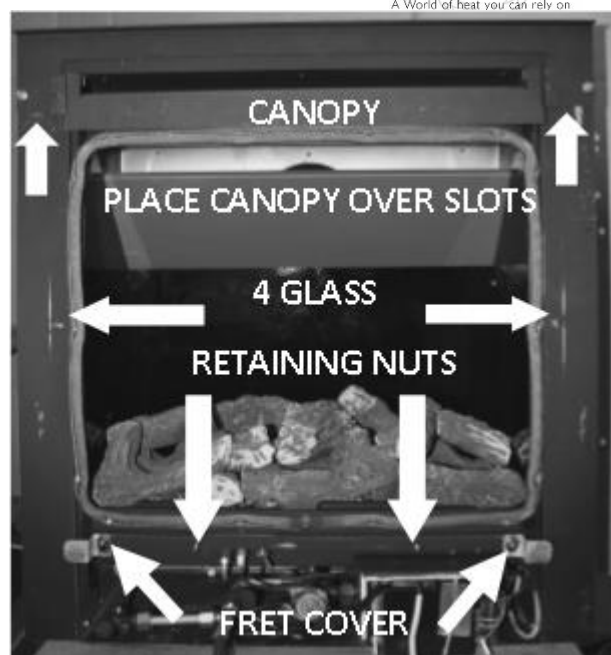

On stubborn stains (where the appliance has been used for a long period without glass panel being cleaned), use a new **Brillo Pad** well wetted with the Hob cleaner applied directly to it.

Ensure all the residues of the cleaner are removed with a damp cloth and the glass panel is completely dry before fitting to the appliance.

## [SECTION FOUR Cleaning & Fuel Bed Laying Continued \(user instructions\)](#)

Note: - If the fuel bed has not been placed correctly, causing the gas flame to contact the glass this may result in glass staining that cannot be removed by cleaning.

Re-assemble in reverse order ensuring the seal is compressed evenly at the top and bottom.

Re-fit the top canopy before re-fitting the trim and fret or fascia and before re-lighting.

### **CLEANING AND REPLACING Fuel Bed Parts**

**Important:** - Refer to the 'Health & Safety Notice located on page 3 of this booklet before cleaning or replacing any refractory material.

**Use only the Fuel Bed part provided NO OTHER FUEL BED PARTS SHOULD BE ADDED to the appliance.**

**If any Fuel Bed Parts are broken, then they must be replaced before the appliance is used.**

The fuel bed parts are delicate and should be handled with great care.

The loose parts should be removed for cleaning. They can be brushed very gently with a soft brush to remove dust or any deposits.

A vacuum cleaner may only be used after all the loose logs have been removed. Please ensure you have replacement vermiculite and Embaglow available.

**NOTE: During operation some sooting will be evident on the fuel bed whether running on the high or low setting. This may be reduced by running on the opposite setting for 15 minutes prior to switching the fire off i.e. If fire is running on high, then turn to low for 15 minutes before turning off. This will not eliminate all soot but helps keep it to a minimum.**

### **LOG BED LAYOUT**

- The Log set as shown consists of:
- 1 Bag of vermiculite
- 10 log shapes
- 1 Pouch of Embaglow

Place the front sump in position as shown.

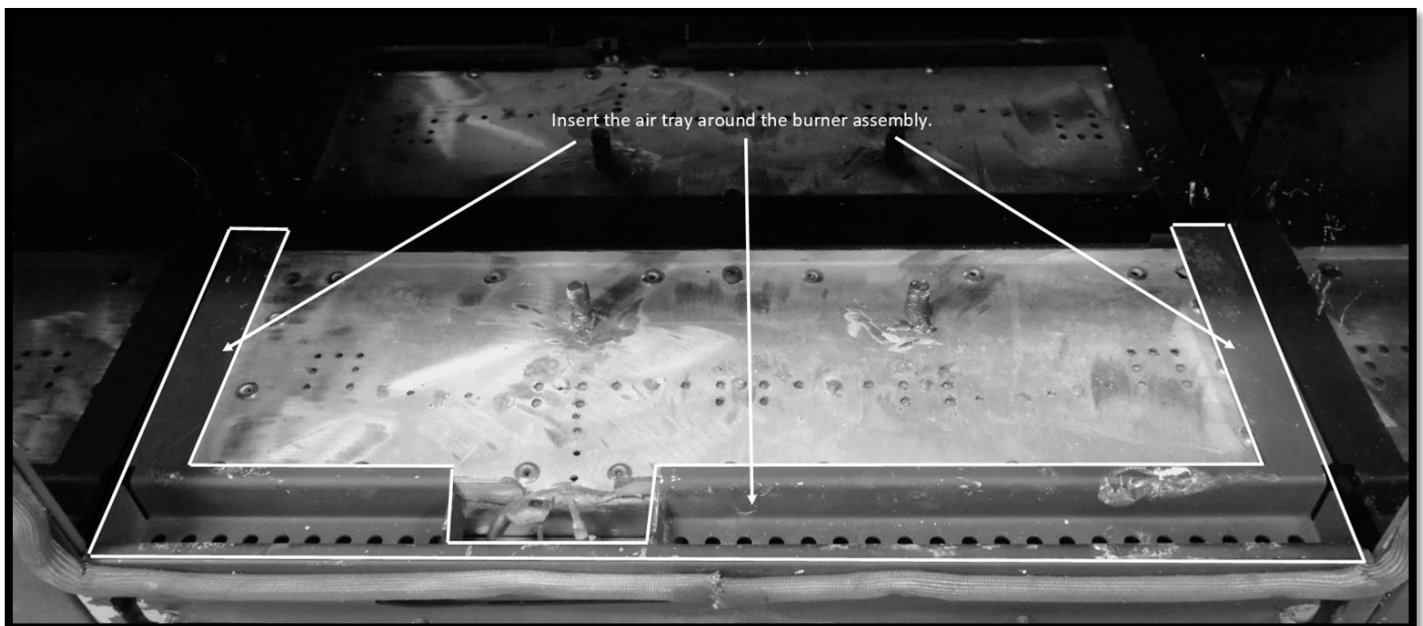

Place shape No1 directly onto the studs as shown.

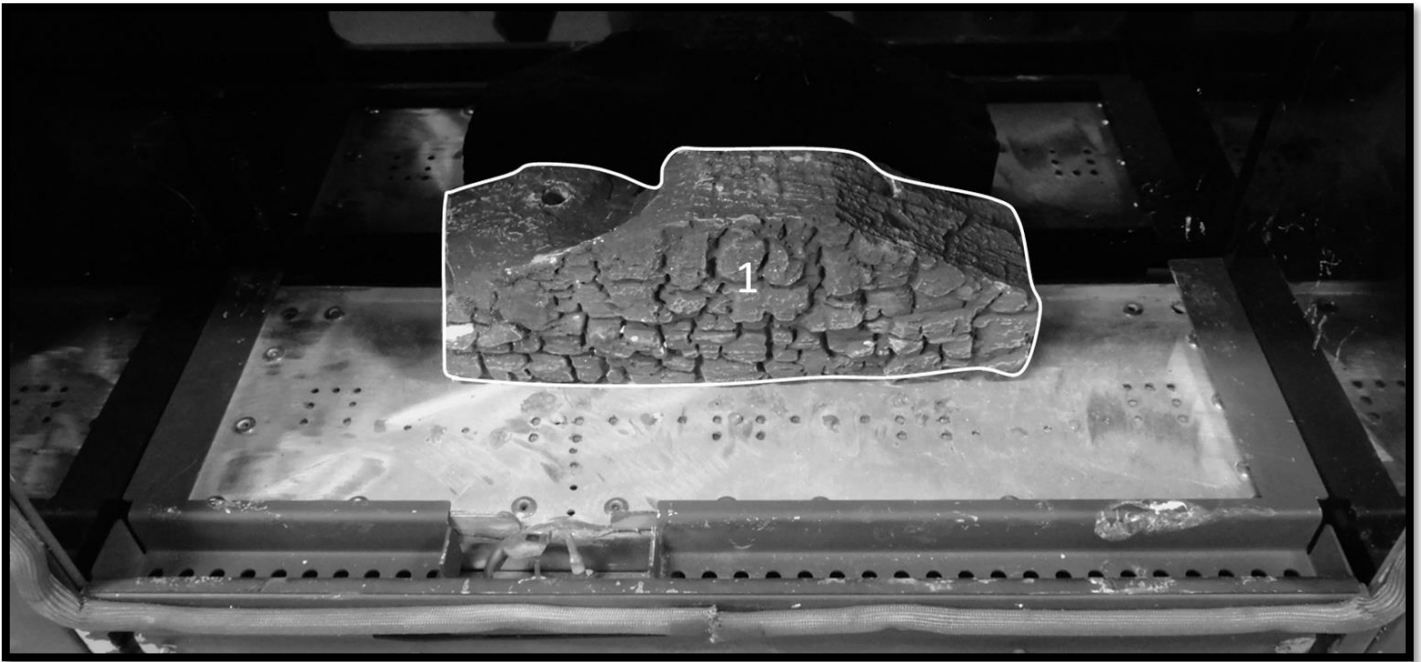

Place a thin layer of vermiculite over the burner as shown.

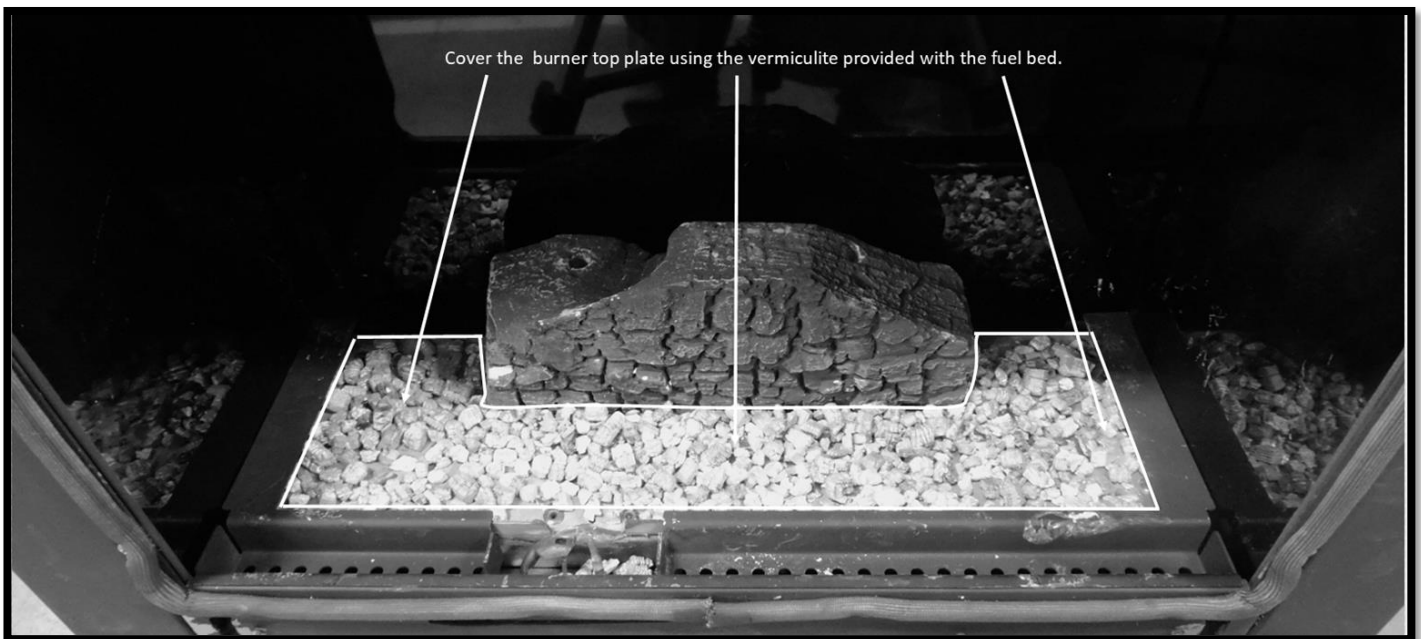

Loosely tease out of the Embaglow into a fine nest and place in the areas as shown.

**Take great care not to get any on the pilot.**

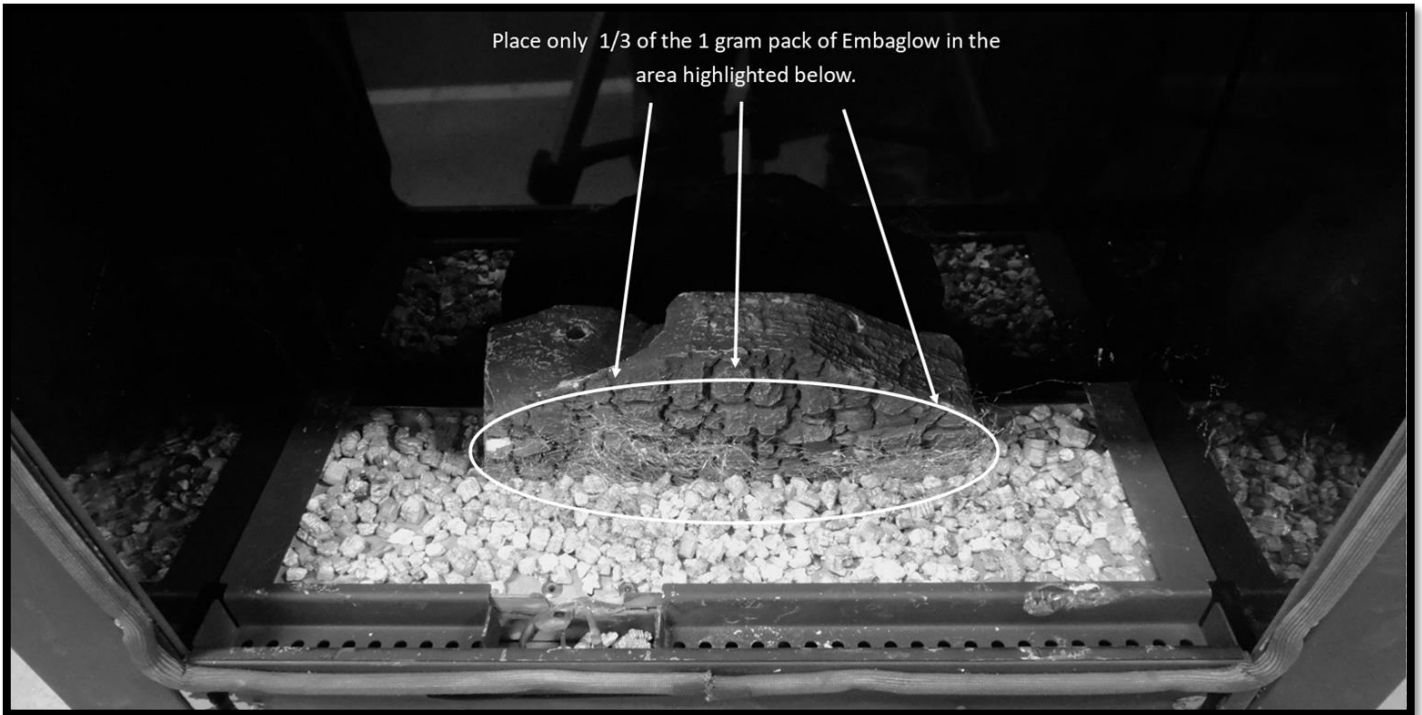

Position shape number 2 as shown below.



Position shape number 3 as shown below.

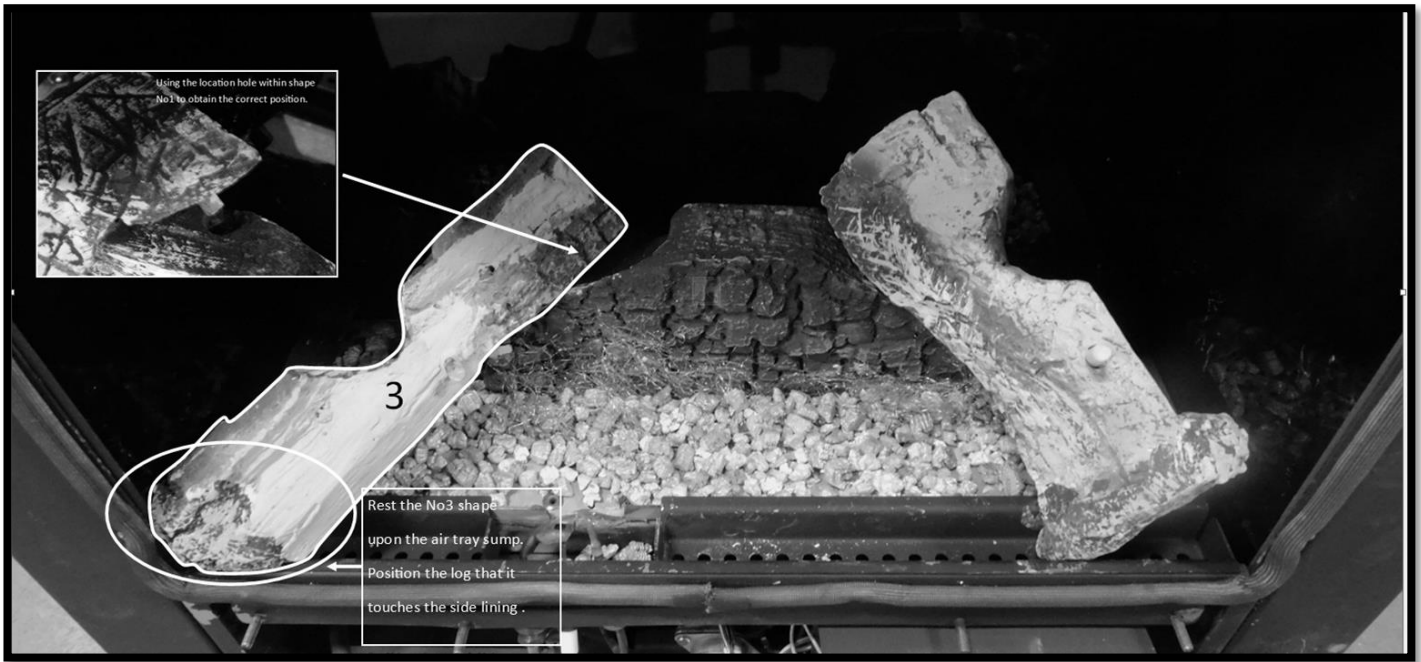

Position shape number 4 as shown below.



Position shape number 5 as shown below.



Position shape number 6 as shown below.



Position shape number 7 as shown below.

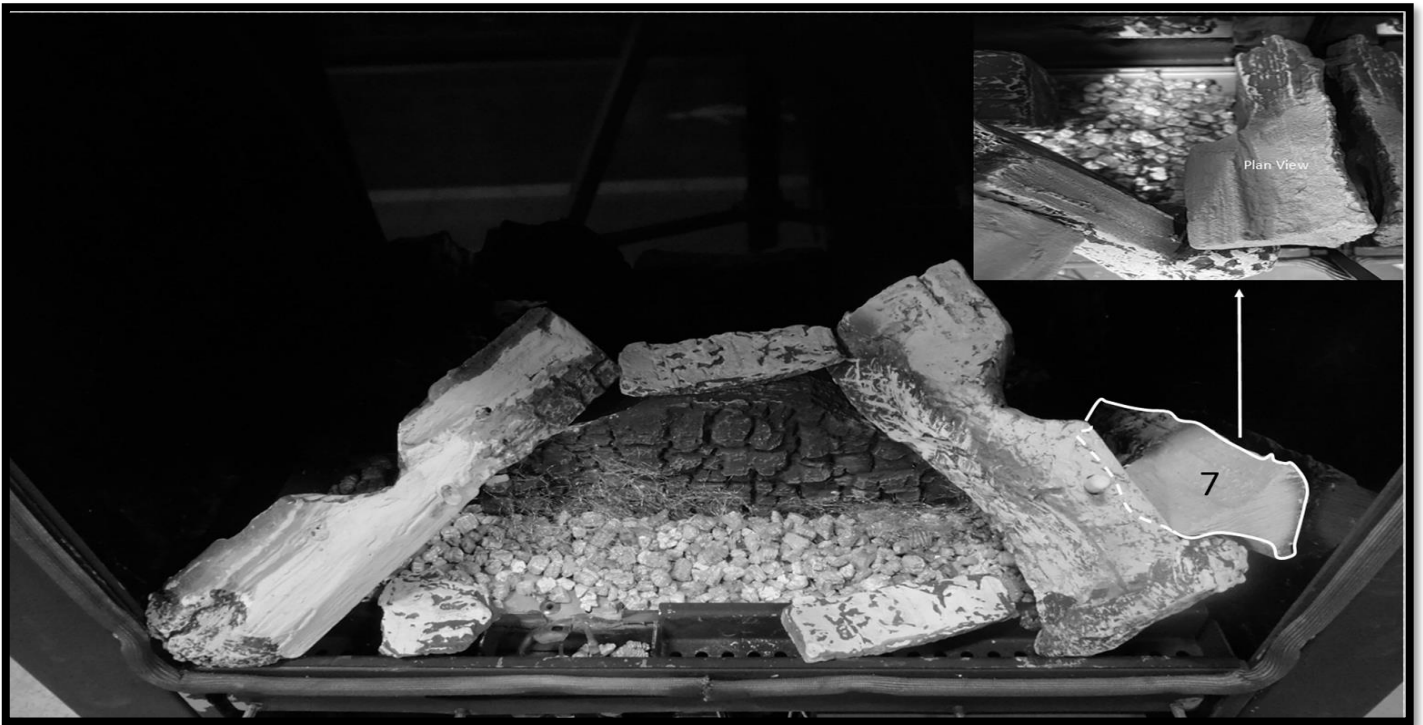

Position shape number 8 as shown below.



Position shape number 9 as shown below.



Position shape number 10 as shown below.

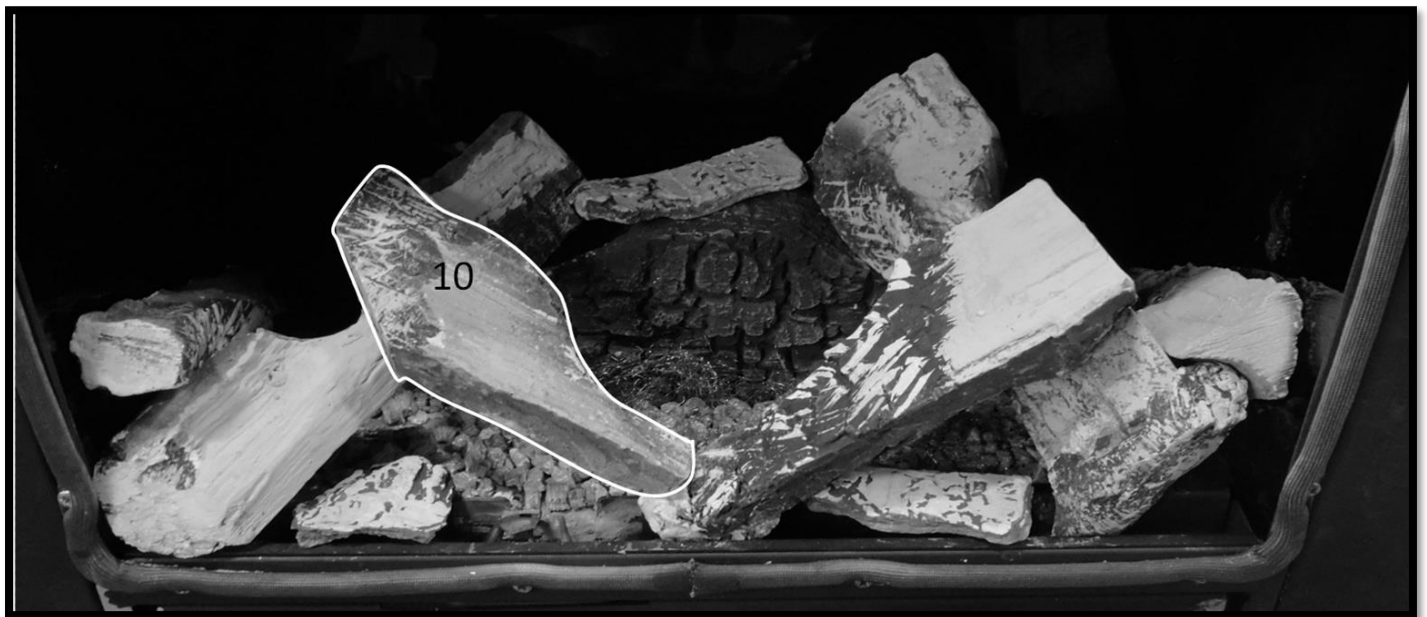



## SECTION FIVE Replacement Parts (user instructions)

The only user removable parts are: -

- Cast fret.
- Top Canopy
- Glass panel, fixing clamps and fret cover.
- Decorative Trim
- Refractory fuel bed components

## SECTION SIX Appliance Data (installation instructions)

Wall Cut-out dimensions:.....	Height	555mm
	Width	405mm
Overall dimensions:.....	Height	599mm
	Width	490mm
Forward Projection:.....	90mm, (From fireplace opening Including typical fret.)	
Weight:.....	38.5kg (Boxed excluding fret)	
	37kg (Unboxed excluding fret)	
Flue Length and duct length:.....	100mm (minimum) to 600mm (maximum)	

Standard length supplied with fire is 600mm which can be cut down to the required length.

### **No additional lengths or extensions can be used.**

Injector .....	MK 290
Pressure Test Point Location:.....	Gas inlet elbow
Gas Connection:.....	8.0mm O/D, tube.
Data Badge Location:.....	On the appliance base behind decorative front.
Handset Replacement Batteries 2 x AAA 1.5V	
Power Supply Type Plug – Input: 100-240 VAC 50/60 Hz, 0.2A	

MODEL	NG(G20)	
Category of appliance	C <sub>II</sub>	
NO <sub>x</sub> Class	5	
Efficiency Class	1	
Gas Category	I <sub>2H</sub>	
Gas Type	G20 Natural Gas	
Gas Pressure +/- 1.0mbar	20 mbar	
Gas Input (Max)	3.9 kW	0.390 M3/H
(Min)	2.4 kW	0.240 M3/H
Injectors size	290	

*NOTE: The efficiency of this appliance has been measured as specified in BS EN613-2001 and the result is 77.2% natural gas. The gross calorific value of the fuel has been used for this efficiency calculation. GasTec have certified the test data from which it has been calculated. The efficiency value may be used in the UK Government's Standard Assessment Procedure (SAP) for energy rating of dwellings.*

## SECTION SEVEN Regulations and Warnings(installation instructions)

- THIS APPLIANCE MUST ONLY BE INSTALLED IN GREAT BRITAIN.
- THE APPLIANCE IS AVAILABLE IN NATURAL GAS ONLY.
- CONFIRM THAT THE APPLIANCE IS SUITABLE PRIOR TO INSTALLATION (G20 FOR NATURAL GAS) (REFER TO DATA BADGE ON BASE OF APPLIANCE). *NOTE: THE APPLIANCE SHOULD ONLY BE USED ON THE APPROPRIATE GAS SPECIFIED. IT IS NOT SUITABLE FOR CONVERSION FROM ONE GAS TO THE OTHER.*
- THIS APPLIANCE MUST BE INSTALLED ON A SUITABLE OUTSIDE WALL.
- NO SPECIAL VENTILATION BRICKS OR VENTS ARE REQUIRED INTO THE ROOM CONTAINING THE APPLIANCE.
- IT IS THE LAW THAT ALL GAS APPLIANCES MUST BE INSTALLED BY A COMPETENT PERSON, I.E. A GAS SAFE REGISTERED INSTALLER, IN ACCORDANCE WITH THE CURRENT GAS SAFETY (INSTALLATION AND USE) REGULATIONS 1994 (AS AMENDED), ALL RELEVANT PARTS OF THE LOCAL AND NATIONAL BUILDING REGULATIONS AND ALL RELEVANT RECOMMENDATIONS OF THE CURRENT BRITISH STANDARDS. FAILURE TO DO SO COULD LEAD TO PROSECUTION.

**THE FOLLOWING ARE THE RELEVANT CODES OF PRACTICE AND BRITISH STANDARDS: -**

**B.S. 5871 PART 2**

**B.S. 5440 PART 1**

**B.S. 6891**

**B.S. 1945**

**Note: - This appliance must be installed to current versions of the above standards and include any relevant amendments.**

**THE BUILDING REGULATIONS ISSUED BY THE DEPARTMENT OF THE ENVIRONMENT.**

**THE BUILDING STANDARDS (SCOTLAND) (CONSOLIDATED) REGULATIONS ISSUED BY THE SCOTTISH DEVELOPMENT OFFICE.**

**PRIOR TO THE INSTALLATION ENSURE THAT THE LOCAL DISTRIBUTION CONDITIONS**

**(IDENTIFICATION OF TYPE OF GAS AND PRESSURE) AND ADJUSTMENT OF THE**

**APPLIANCE ARE COMPATIBLE. (G20 @ 20mbar Natural Gas Version)**

### **warnings**

- As this appliance has components, which get very hot as with all such fires, it is recommended that a fireguard should be used for the protection of children, the elderly, or the infirm. Fireguards should conform to B.S.6539 (1984) (Fireguards for use with solid fuel appliances).
- During initial use, an odour may be evident. This will soon disappear if the fire is run on its maximum setting for a few hours.
- Care must be taken to prevent any damage being caused to surrounding soft furnishing or decoration, e.g., wall coverings may become discoloured if placed too close to the appliance.

### **IMPORTANT NOTES**

This appliance is a fuel effect gas fire designed for use in locations that do not have a conventional chimney.

Document J states: a carbon monoxide alarm should be fitted upon the installation of fixed combustion appliance.

This appliance is intended for use on a gas installation with a governor meter.

## SECTION EIGHT Siting the Appliance (installation instructions)

(When installing in a timber framed dwelling reference must be made to the specific installation requirements stated in **Section 10 Installing the Appliance in Timber Framed Dwelling**).

**THERE ARE TWO TYPES OF INSTALLATION** (into conventional masonry walls): -

- The appliance body can be recessed back into the brickwork cavity so that the appliance is flush fitting with the wall or fireplace back panel, see Installation Instructions,

**OR**

- With a dummy chimneybreast constructed forward into the room to take up the 180mm depth of the firebox. This depth can be reduced if a deep rebated surround is also used the rebate depth can be deducted from the dummy breast depth any surround used must meet the specification stated later in this section. Prior to installing the appliance, all combustible materials must be removed from the rear faces as described in Section 10.

### GENERAL REQUIREMENTS

- The flue and air duct length must be between 100mm to 600mm. The fire is supplied with a standard pipe length of 600mm. The flue and air duct must not accommodate any bends.
- The flue outlet must terminate on a suitable outside wall.
- The minimum flue terminal clearances, which must be maintained, are as shown below.

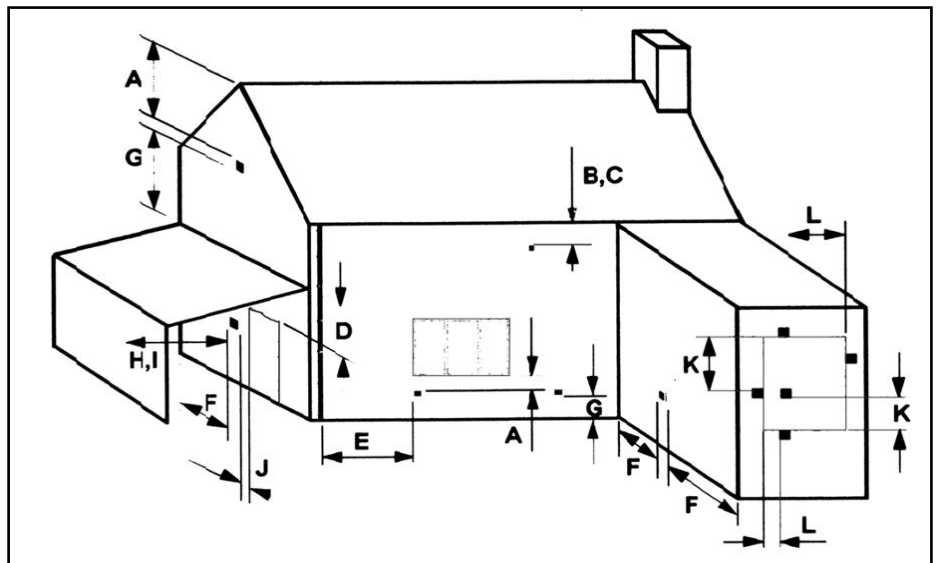

A.	Directly below an openable window or other opening. E.g., air brick.....	300mm
B.	Below gutters, soil pipes or drainpipes.....	300mm
C.	Below eaves.....	300mm
D.	Below balconies or car port roofs.....	600mm
E.	From vertical drainpipes and soil pipes.....	75mm
F.	From internal and external corners.....	300mm
G.	Above ground, roof, or balcony level.....	370mm
H.	From a surface facing the terminal.....	600mm
I.	From a terminal facing the terminal.....	1200mm
J.	From an opening in a car port into a dwelling e.g., door, window, etc.....	1200mm
K.	Vertically from a terminal on the same wall.....	1500mm
L.	Horizontally from a terminal on the same wall.....	300mm

**Note: These dimensions are taken from the center of the flue outlet.**

**\*To minimise the risk of cracking due to heat expansion the use of a 3-piece back panel is recommended\***

Please note that curtains should not be positioned above the appliance at a distance less than specified on the shelf chart below.

- The back panel of the surround must have a cut-out within the maximum and minimum dimensions as shown.
- Ensure that gas supply is suitably sited.
- A non-combustible hearth must be provided beneath the appliance if the appliance is fitted at low level (less than 150mm from floor). The hearth must have a minimum thickness of 12mm and the perimeter 50mm above floor level. The hearth must extend the full width of the appliance and must project forward a minimum of 100mm in front of the appliance.
- Alternatively, the appliance may be fitted without a hearth (Hole in the Wall type installations), 150mm min. from the floor to the base of appliance.

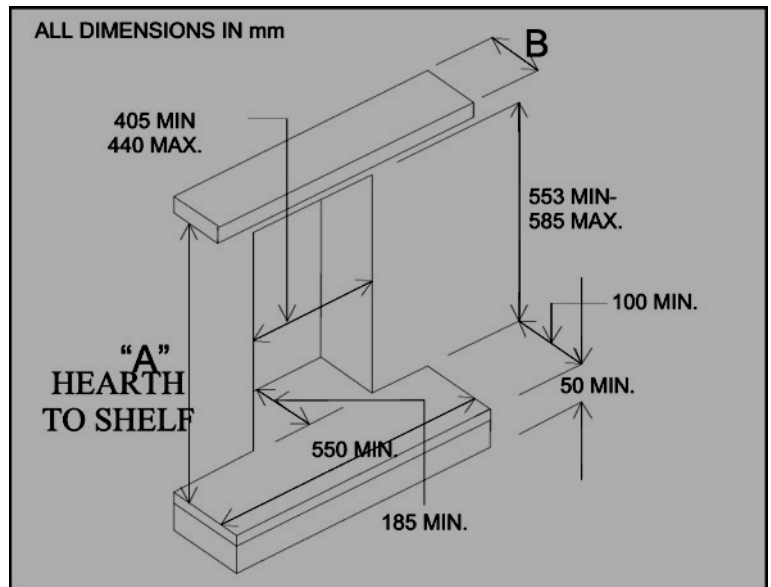

- The minimum clearance from the hearth (base of appliance) to the underside of a combustible shelf should be determined using the shelf chart.
- Minimum width between vertical sides of combustible surround should not be less than 800 mm provided fire is central to the surround and sides do not project more than 150 mm. When vertical side forward projection is increased by 12.5 mm add 50 mm to inside width of surround.
- Check with the supplier or manufacturer that the surround meets 150°C minimum rating (attention should especially be given to manmade materials such as resin).
- When installing in a timber framed dwelling reference must be made to the specific installation requirements stated in **Section 10 Installing the Appliance in Timber Framed Dwelling.**

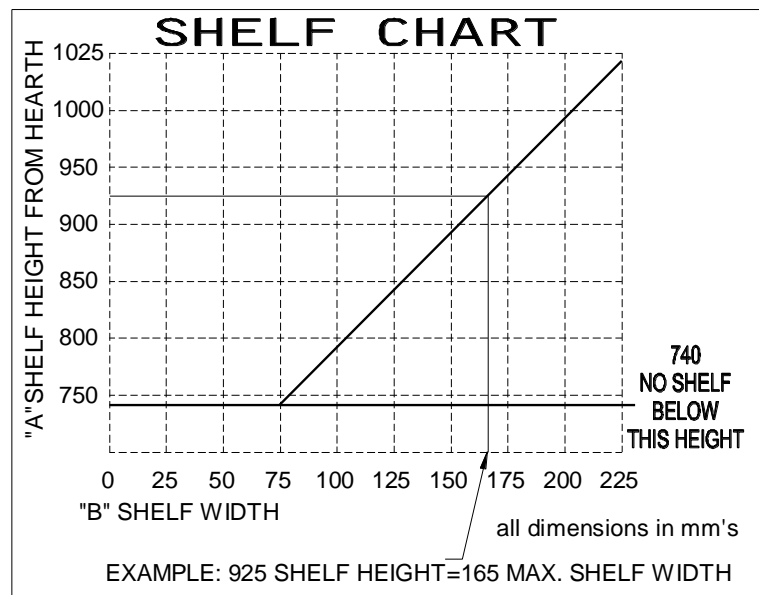

- **\*Please note - Appropriate measures should be taken when installing into a working flue system i.e., out through an existing chimney \***

## SECTION NINE Preparing the Appliance for Installation (installation instructions)

- Carefully unpack the appliance from the carton and check the contents.
- Remove the refractory components from the inside of the appliance.
- The appliance is now ready for installation.

## SECTION TEN Power Lead Routing

The power supply for this appliance is provided via AC power adaptor 230 VAC. The main cable terminates the rear Right hand side of the firebox. The length of the cable provided with the appliance is 1.65 metres. Care must be taken when siting the firebox not to trap the exposed main cable within the builders opening.

Note: the power cable link to the transformer must be accessible for re-pairing handset.

The cable can be routed using the following two methods,

Method 1,

Passing the cable through the side of the chimney breast. It is good practice to run the cable within a sleeve of at least 15mm internal diameter, sealing the sleeve using a suitable sealant at the point the sleeve / cable terminates the chimney masonry.

Method 2,

Remove a channel out of the outer skin of the Dry / wet plaster of the chimney breast up to the main power point. Again, it is good practice to run the cable within a sleeve of at least 15mm internal diameter.

With power points that exceed the 1.65 metre distance, an optional 2.0 metre extension cable is available Part No 7147.

The cable system consists of retro fitting plug sockets which offers the following options. (Please see figure 5).

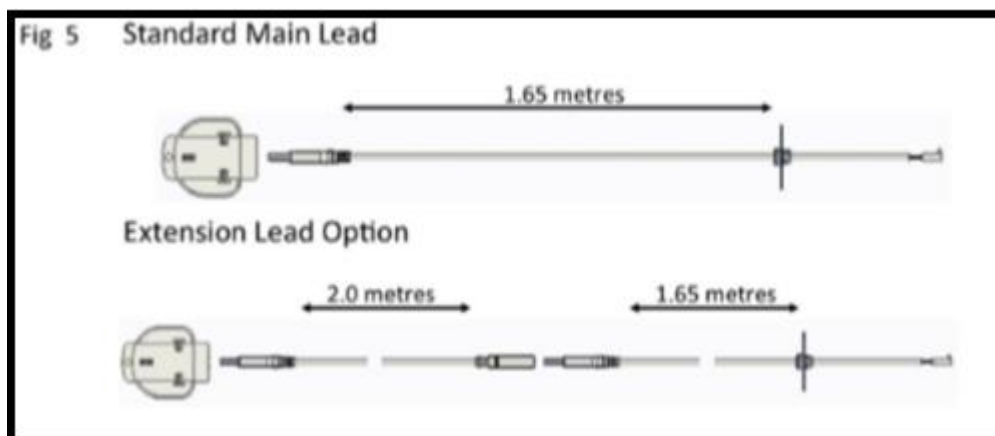

## SECTION ELEVEN To Install the Appliance (installation instructions)

### INSTALLING THE APPLIANCE INTO CAVITY WALL

(When installing in a timber framed dwelling reference must be made to the specific installation requirements stated later in this **Section 'Installing the Appliance in Timber Framed Dwelling'**).

- Ensure it is a suitable outside wall constructed of non-combustible materials and that the flue position meets the requirements previously described in **Section 8**.
- Mark a horizontal line on the wall at the intended hearth surface or appliance base height (50mm min for Hole in Wall installation (the skirting board must be cut away from behind the fire)).
- Mark a vertical line on the wall at the intended centre of the appliance up from the horizontal line for a height of 565mm.
- Mark two more vertical lines 203mm either side of the centre line for a height of 565mm.
- Mark a horizontal line at a height of 565mm above the hearth line, joining the two outside lines together.
- Mark the position for a lintel above the top horizontal line.
- Mark a short horizontal line so it crosses the centre line at 438mm above hearth level line. This is the centre point for the flue hole.
- Using a long masonry drill, make a pilot hole completely through the wall, ensure the hole is drilled accurately at the centre and square to the wall both horizontally and vertically.
- Cut out the brickwork of the inner skin of the cavity wall for the lintel, and position and fix the lintel with mortar.
- Cut out the brickwork under the lintel, between the two outside vertical lines into the cavity. Ensure the cut-out width is square, try the appliance into the opening.
- Using 150mm (6") core drill, cut a hole following the pilot hole, drill from the outside through to the cavity.
- Remove any cavity insulation from the cut-out opening and for a further 100mm into the cavity gap each side and above.
- Pack "Rockwool" around the sides and top of the opening into the cavity for a depth of 100mm.
- Lay the hearth if required so that it is positioned correctly to the horizontal line.
- Position and fix the back panel and surround if required.
- Offer the appliance into the opening and mark through the gas pipe entry hole (see connecting the gas supply later in this manual).
- Pass a tape measure through the core-drilled hole and record the distance from the back of the spigots to the surface of the outside wall.

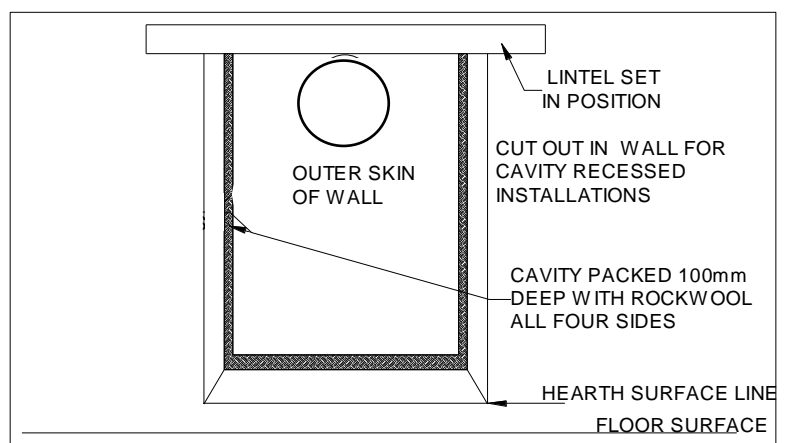
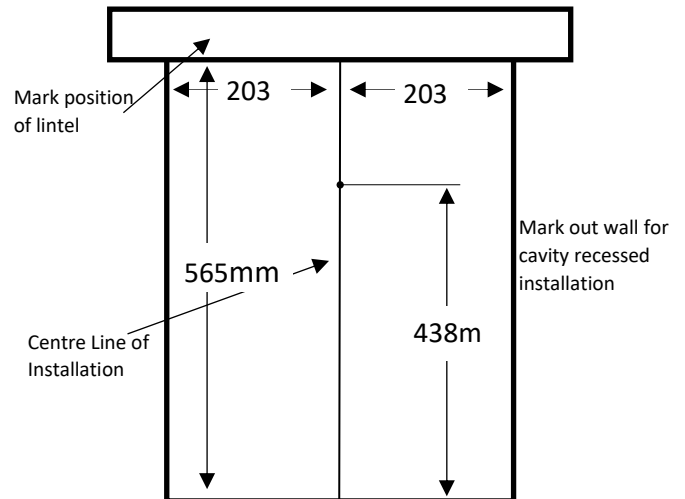

- cut these lengths from the 150mm diameter pipe and 100mm diameter pipe. **NOTE THE INNER SHOULD BE 15MM LONGER THAN THE OUTER!**
- Remove the appliance from the opening and position the gas supply (see connecting the gas supply later in this manual), taking account of the relative gas regulations appertaining to a gas pipe in a cavity. Note the gas feed must be fitted with an isolation valve.
- Peel the backing off the length of foam seal and affix to the rear outer edge of the appliance flange.
- Push the appliance back into the opening and fill any space behind the appliance with “Rockwool”.
- Complete the gas connection (see connecting the gas supply later in this manual).
- Drill the four fixing holes through the hole in the flange of the appliance and fix back using plug and screws.
- Pass the flue terminal through the core drilled hole and check the flue fully engages on the flue spigots.
- Mark the fixing holes, remove the terminal and drill the wall to accommodate the wall plugs.
- Run two beads of flue seal or fire cement around the inside of both pipes to ensure airtight seal.
- Fit the terminal to the wall and fix back with the screws provided.
- If the flue outlet is fitted below 2m from the floor or a balcony, then the flue guard must be fitted.

**INSTALLING THE APPLIANCE INTO DEEP REBATED FIRE SURROUND OR DUMMY CHIMNEY BREST.**

**Additional duct pipe/s will be required.** (When installing in a timber framed dwelling reference must be made to the specific installation requirements stated later in this **Section ‘Installing the Appliance in Timber Framed Dwelling’**).

- Ensure it is a suitable outside wall constructed of non-combustible materials and that the flue position meets the requirements previously described.
- Mark a horizontal line on the wall at the intended hearth surface or appliance base height (150mm min. for Hole in Wall installation) the skirting board must be cut away from behind the fire.
- Mark a vertical line on the wall at the intended centre of the appliance up from the horizontal line for a height of 565mm.

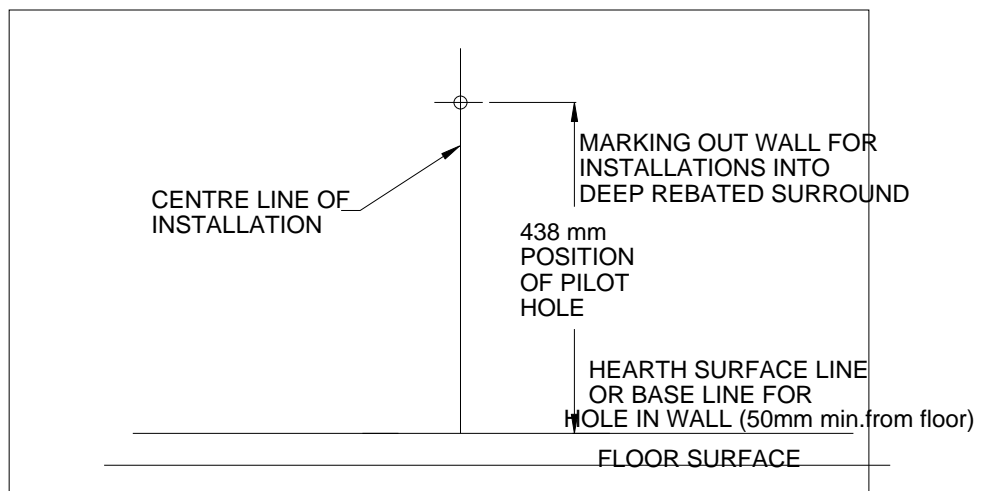

- Mark a short horizontal line so it crosses the centre line at 438mm from the hearth level line. This is the centre point for the flue hole.
- Using a long masonry drill, make a pilot hole completely through the wall, ensure the hole is drilled accurately at the centre and square to the wall both horizontally and vertically at the cross point previously marked.
- Using 150mm (6”) core drill, cut the hole following the pilot hole, drill from the outside of the dwelling through to the cavity, and from the inside through to the cavity.
- Remove any combustible material that may be present if the rear of the appliance is contacting the wall i.e., ensure no battens etc., behind dry lining.
- Lay the hearth or a non-combustible base (for Hole in Wall) so that it is positioned correctly to the horizontal line.



- Temporally position and fix the back panel and deep surround, or construct a dummy chimney breast as required, avoiding combustible materials coming near the appliance or the flue, leaving access to pack around the appliance with “Rockwool”.
- Offer the appliance into the opening and mark through the gas pipe entry hole (see connecting the gas supply later in this manual).
- Pass a tape measure through the core-drilled hole and record the distance from the back of the spigots to the surface of the outside wall.
- Pass a tape measure through the core-drilled hole and record the distance from the back of the spigots to the surface of the outside wall.
- cut these lengths from the 150mm diameter pipe and 100mm diameter pipe. **NOTE THE INNER SHOULD BE 15MM LONGER THAN THE OUTER!**
- Remove the appliance from the opening and position the gas supply (see connecting the gas supply later in this manual), taking account of the relative gas regulations appertaining to a gas pipe in a cavity. Note the gas feed must be fitted with an isolation valve.
- Peel the backing off the length of foam seal and affix to the rear outer edge of the appliance flange.
- Push the appliance back into the opening and fill any space behind the appliance with “Rockwool”.
- Complete the gas connection (see connecting the gas supply later in this manual).
- Drill the four fixing holes through the hole in the flange of the appliance and fix back using plug and screws.
- Pass the flue terminal through the core drilled hole and check the flue fully engages on the flue spigots.
- Mark the fixing holes, remove the terminal and drill the wall to accommodate the wall plugs.
- Run two beads of flue seal or fire cement around the inside of both pipes to ensure airtight seal.
- Fit the terminal to the wall and fix back with the screws provided.
- If the flue outlet is fitted below 2m from the floor or a balcony, then the flue guard must be fitted.
- Remove the appliance from the opening and position the gas supply (see connecting the gas supply later in this manual), taking account of the relative gas regulations appertaining to a gas pipe in a cavity.
- Permanently fix the deep rebated surround in position and pack the void behind the fascia panel of the deep rebated surround with “Rockwool”. Pack 150mm thickness of “Rockwool” over the appliance top and side if it is fitted into a dummy chimneybreast and fill any space between the appliance and the outside wall.
- Position and seal the pipes to their respective spigots on the rear of the appliance (use flue seal or fire cement to ensure airtight seal, it must not obstruct the flue).
- Peel the backing off the length of foam seal and affix to the rear outer edge of the appliance flange.
- Push the appliance back into the opening and fill any space behind the appliance with “Rockwool”.
- Complete the gas connection (see connecting the gas supply later in this manual).
- Drill the four fixing holes through the hole in the flange of the appliance and fix back using plus and screws.
- If the flue outlet is fitted below 2m from the floor or a balcony, then the flue guard must be fitted.

## **TIMBER FRAMED DWELLING**

This method allows for installation in timber frame buildings. Where removal of any part of the inner timber leaf of the wall is involved the structural integrity of the wall must be maintained and the advice of your local Building Control Department should be sought. If the property is under N.H.B.C. cover, it is advised that their advice should also be sought. Reference should be made to the British Gas Publication DM2 "Guide for Gas Installations in Timber Frame Housing" or Gas Safe "Gas installations in Timber Frame Buildings" ISBN1-902632-30-3

Special attention must be paid to the location of the studwork frames of the inner leaf and the appliance positioned accordingly. Electrical cables and pipework that run within the inner timber leaf must also be located and considered when positioning the appliance.

The following methods of installation may be adapted for use in timber frame buildings providing extra care is taken to protect combustible materials from contact with hot surfaces.

### **Method 1 (For installation into a extended fire surround or false chimney breast)**

- An insulation material (20mm "Superlux" or equivalent) must protect all combustible surfaces (including plasterboard) situated within the opening. A minimum clearance of 50mm must be allowed between the appliance case (rear, top and sides) and the material used to line the opening. The base of the opening must be non-combustible.
- Wrap the appliance body (top, rear and sides) and flue tube with "Rockwool" (50mm minimum thickness).
- Where the flue pipe pass through the inner timber leaf a concentric hole 250mm diameter should be cut around the pipe, allowing a minimum 50mm air gap all around the pipe. A non-combustible sleeve 250mm diameter must be fitted to this clearance hole.
- To ensure that any condensation formed on the duct pipes does not drip on to the inner wall a length of galvanised wire must wrapped around each flue pipe and secured in position by twisting the ends together. Ensure that the twisted ends are located at the bottom of the pipes and the wire is centrally located within the cavity.
- The vapour barrier on the back of the inner timber leaf should be carefully cut and fixed to prevent ingress of damp into the plasterboard layer.

### **Method 2 (For installation into the inner timber leaf of the wall)**

- Find a suitable position between the wall panel frames and carefully open a hole (minimum dimension 500mmW x 605mmH x 230mm deep) this will ensure 50mm minimum clearance around the appliance body Note: the 230mm could be reduced to 200mm if no combustible material is left between the back of the fire box and the outer skin on brickwork. Careful attention must be made to securing the damp proof membrane back into position. (Note: To achieve the minimum depth requirement it may be necessary to deepen the cavity by building up the wall surface with an appropriate non-combustible material.)
- Line the exposed cavity (top, rear and sides) with an insulation material (20mm "Superlux" or equivalent) to form a boxed chamber. The base of the opening must be non-combustible.
- Wrap the appliance body (top, rear and sides) and both flue tubes with "Rockwool" (50mm minimum thickness).
- 
-

- Where the flue pipes pass through the inner timber leaf, concentric hole 250mm in diameter should be cut around the flue pipe, allowing a minimum 50mm air gap all-round the flue pipe. A non-combustible sleeve 250mm diameter must be fitted to this clearance hole.
- To ensure that any condensation formed on the duct pipes does not drip on to the inner wall a length of galvanised wire must be wrapped around each flue pipe and secured in position by twisting the ends together. Ensure that the twisted ends are located at the bottom of the pipes and the wire is centrally located within the cavity.
- The vapour barrier on the back of the inner timber leaf should be carefully cut and fixed to prevent ingress of damp into the plasterboard layer.

**NOTE:** Neither the appliance nor the “Rockwool” insulating pad may overhang the cavity space. Routing of the gas supply must be carried out in line with the recommendations specified in the British Gas Publication DM2 ‘Guide for gas installation in Timber Frame Housing.

## **CONNECTING THE GAS SUPPLY**

**TURN OFF ANY GAS APPLIANCES THAT ARE FED BY THE METER AND ISOLATE THE GAS SUPPLY BY TURNING OFF AT THE METER.**

- Connections may be made from the front of the appliance from either the left or the right in 8mm-dia. pipe or a concealed connection from the rear of the appliance a hole with a grommet is provided at the rear.
- An isolating cock is fitted in the supply feed to the fire to facilitate servicing. It may be rotated for right gas connection.
- When a concealed gas fitting from the rear is required, it is necessary to route the pipe to the left side of the unit, considering the requirements of BS 6891 1988 dealing with enclosed pipes.
- When installing the firebox into a cavity wall, any part of the installation pipe work installed in the void open to the cavity wall must be enclosed in a gas tight sleeve. It must be sealed at the point at which the sleeved installation pipe enters the fire (The Gas Safety (Installation and Use) Regulations Certificate of exemption number 1 of 1996). Where the pipe enters the fire, the outer sleeve must be sealed to the grommet and the pipe must be sealed to its outer sleeve using suitable mastic.

## **CHECKING GAS SOUNDNESS**

- Complete gas connection to the fire and check for gas soundness in accordance with current codes of practice.

## SECTION TWELVE Assemble the Appliance (installation instructions)

- Position the refractory fuel bed components as described in section four of this manual, it is important that the fuel bed is positioned exactly as described to ensure the correct operation of the appliance. Badly positioned fuel bed components may result in the gas flame being driven forward onto the glass and permanently marking it.
- Slide the top of the Glass Frame under the Glass Frame Bracket on the fire and centralize the slots over the Four fixing studs, making sure the seal inside the glass.
- Start the nuts on these four studs.
- Tighten the Four nuts up evenly ensuring that the glass compresses the seal on all four sides.
- Position the fret apron and secure with two nuts.
- Position the grill fascia so that it hooks centrally over the top flange of the combustion box and covers the front edge of the glass frame.
- Position four magnets in two up each side of the appliance flange and offer the decorative trim up squarely and centrally.

## SECTION THIRTEEN Check Operation of Fire (installation instructions)

### CHECK BURNER PRESSURE AND GENERAL OPERATION

- Remove the screw from the pressure test point on the inlet elbow and fit a pressure test gauge.
- Purge the air from the appliance by operating the appliance (see Section 3). The appliance will spark for approximately 20 second at which point if no ignition is detected the appliance will go to lock out and you must repeat the ignition procedure.
- Check that the electrode is sparking at the gap between the thermocouple tip and the electrode and that the pilot ignition is established. After approximately 20 seconds the main burner will light on the high setting.
- Check that the inlet pressure 20mbar +/- 1 mbar for natural gas or 37mbar +/- 1 mbar for L.P.G.
- Refit pressure test point screw and check for leaks.

## SECTION FOURTEEN Instruct and Advise the Customer (installation instructions)

- Demonstrate the lighting and extinguishing procedure to the consumer/user and the removal and refitting of the decorative trim for cleaning.
- Explain that for the first few hours of the fire operating there will be an initial odour. This is due to the curing of the paint, the appliance should be operated on its high setting, and it is recommended that a window is left open until that odour has completely disappeared.
- Instruct on the glass removal and refitting.
- Instruct on the fuel bed cleaning and advise that a vacuum cleaner can be used but only after all the loose fuel bed shapes have been removed. **Refer to 'Health & Safety Notice (See Section One) at the front of this booklet before proceeding.**
- Advise that the appliance should be serviced annually by a competent person i.e. a **Gas Safe registered engineer** in accordance with these instructions.
- Although the appliance is fitted with a glass front which acts as a dress guard it is strongly recommended that a fireguard should be used for the protection of children, the elderly or infirm. Fireguards should conform to B. S. 6539 (1984) (Fireguards for use with solid fuel appliance).

- Examine the shapes for signs of cracking and replace if necessary. (IMPOPRTANT) see layout procedure in section fuel bed layout of this manual before attempting to replace items, which should only be replaced as a complete set with no extra shapes added.
- **Hand these instructions to the user.**

## SECTION FIFTEEN Maintenance Instructions (maintenance instructions)

### General

- Servicing should be carried out annually by a competent person such as a Gas Safe-registered person in accordance with the relevant regulations, to ensure the safe and correct operation of the appliance.

**Warning: - Before commencing any service or replacement of parts, turn off the gas supply to the fire.**

- After servicing check for gas soundness.
- When ordering spare parts please quote appliance name and serial number these can be found on the data badge, which is located on the appliance remove the decorative fire front for access.
- If soot has accumulated check to establish cause, rectify and clean flue accordingly.

**Important: - Refer to 'Health & Safety Notice (See Page 3) at the front of this booklet before removing the fuel bed components.**

- Examine the coals for signs of cracking and replace if necessary. (IMPORTANT) see coal layout procedure in section four of this manual before attempting to replace coals, which should only be replaced as a complete set with no extra coals added.
- Check pilot aeration holes for linting, use a vacuum cleaner to remove any lint taking care not to damage the pilot head.

### Replacement of Gas Control

1. Turn off the gas supply by the Restrictor Elbow and disconnect.
2. Remove the stove front panel.
3. Remove Glass (See Section Four.)
4. Remove all loose fuel bed components.
5. Disconnect battery leads and remove appliance battery pack. Detach remote control eye from hearth. (See Section Seven when repositioning.)
6. Remove the fixing nut securing the valve carrier unit into the casing.
7. Disconnect fire at inlet elbow and remove burner unit from the casing.
8. Disconnect the thermocouple from the rear of the gas valve.
9. Undo the three compression nuts securing the pipes to the gas valve and remove the two screws fixing the valve to the bracket.
10. Clean, service or replace gas valve.
11. Re-assemble in the reverse order.
12. Turn on the gas supply, check for soundness and re-commission appliance.

### Replacement of Injector

1. Remove the stove front panel and turn off the gas supply ay the isolation cock.
2. Remove the glass and fuel bed components as described earlier in this manual.
3. Undo and remove the 2 screws holding the burner in place.

4. Carefully remove the burner lifting from the right-hand end of the burner.
5. Loosen and remove the injector.
6. Clean or replace the injector and replace in reverse order, ensuring that the connection to the injector fixing is sound air test if in doubt.
7. Turn on the gas supply, check for soundness and re-commission.

### **Replacement of the Thermocouple**

1. Open the door and remove the front panel.
2. Remove the glass and fuel bed components as described earlier in this manual.
3. Turn off the gas supply by the Restrictor Elbow and disconnect from fire.
4. Remove the HT lead, Pilot feed pipe and thermocouple lead from the pilot assembly.
5. Undo and remove the 2 screws holding the burner in place. Carefully remove the burner lifting from the right-hand end of the burner.
6. Remove the single nut retaining the valve carrier from the stove body.
7. Slacken off the burner injector bottom nut and rotate the valve carrier around the burner pipe to enable access.
8. Replace in reverse order, check all joints are gas tight and recommission.

### **Replacement of the Pilot Injector**

1. Undo the pilot tube nut at the pilot bracket.
2. Pull the pipe gently back taking care not to damage.
3. Remove the pilot injector from inside the pilot bracket.
4. Clean or replace in reverse order, turn on the gas supply, check for soundness and re-commission.

### **REPLACEMENT OF CONTROL UNIT (EDB)**

1. Pull off the cable connections from the E.D.B. board.
2. Unscrew the retaining nut securing the E.D.B
3. Replace in reverse order.
4. Reconnect the battery pack and test the operation of the appliance.

### **Replacement Handset**

Follow the guide stipulated on page 9 of the users' instructions "Changing the handset batteries" to load the batteries into the new handset.

### **Re-Pairing the handset or ECU unit.**

When replacement handset or ECU the two items will need to be re-paired using the following procedure.

Start the pairing process with the power to the appliance turned off.







Make sure that the remote handset has batteries installed then turn the power on to the appliance on.

Within 30 seconds of power on, press any button on the remote handset.

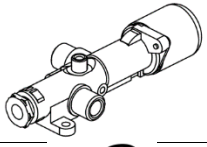
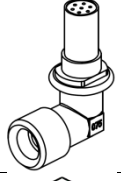
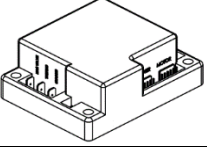
The LED on the handset will start to flash quickly indicating the pairing process has started. If successful pairing is achieved, then the LED will show 5 slow flashes. If pairing fails, there will be 3 long flashes.

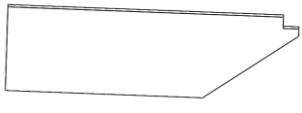
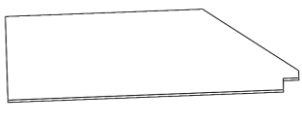
If this happens then remove power to the appliance and repeat the pairing process.

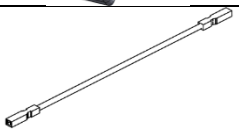
## Shorts Spares list

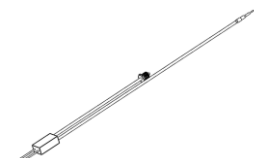
Image	Description	Part number
	Valve	6590
	Injector stamped 290	3208
	EDB	8080
	Front glass panel	8217
	Rear liner	8218
	LH Side Liner	8219
	RH Side Liner	8226
	Handset	8081
	Ignition lead	6646
	Earth lead	6776
	Thermocouple	4739

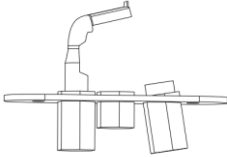
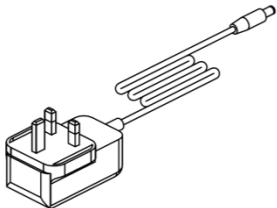
	Pilot gasket	2110
	Pilot Bracket	8674
	Transformer	7145

Charlton and Jenrick Ltd  
Unit D, Stafford Park 2  
Telford  
Shropshire  
TF3 3AR







**Register your appliance online today to active your warranty.**



## BALANCED FLUE GAS FIRE COMMISSIONING CHECKLIST

**This Commissioning Checklist is to be completed in full by the competent person who commissioned the gas fire as a means of demonstrating compliance with the appropriate Building Regulations and then handed to the customer to keep for future reference.**

Failure to install and commission according to the manufacturer's instructions and complete this Benchmark Commissioning Checklist will invalidate the warranty. This does not affect the customer's statutory rights. **PLEASE COMPLETE IN BLOCK CAPITALS.**

Customer name:										Telephone number:									
Address:																			
Gas Fire make and model:																			
Installation location: i.e living/dining room.																			
Gas Fire serial number:																			
Commissioned by (PRINT NAME):										Gas Safe register number:									
Company name:										Telephone number:									
Company address:																			
										Commissioning date:									
Building Regulations Notification Number (if applicable):																			

Site Requirements	Yes	N/A
Is the flue terminal sited and fitted as per the manufacturer's instructions?		
Has a flue guard been fitted?		
<b>Hearth Requirements- where fitted</b>		
Is the hearth constructed from non -combustible material?		
Is the hearth a minimum of 12mm thick with a minimum floor to top surface of 50mm?(BS5871) or as per manufacturer's instructions?		
Is the hearth for open fronted fires a minimum of 760mm wide and has 300mm projecting from the fire opening (BS6871) or to manufacturer's instructions?		
Mounting height (where applicable) has the fire been installed to the correct mounting height- as per manufacturer's instructions?		
<b>Firebox and Fuel Bed</b>		
Has the fuel bed, coals, logs, pebbles etc. been fitted to manufacturer's instructions?		
<b>Gas Supply</b>		
Has an isolation valve inlet elbow been fitted for servicing?		
Has the gas supply been thoroughly purged prior to connection to remove any debris?		
Has a gas tightness test been completed prior to breaking into the gas supply and following completion of installation? (IGEM/UP/1B)		
Has the correct gas type been chosen as per manufacturer's instructions?		
Record burner gas pressure reading? If only the supply pressure is available a gas rate must be undertaken. (GSIUR REG26/9C)		
Record dynamic inlet gas pressure (working pressure) reading (all gas appliances running)		
<b>Installation</b>		
Has the gas fire/convector heater been installed and commissioned in accordance with manufacturer's instructions?		
Has the gas fire/convector heater been installed with the correct clearance to combustible materials, service and general clearances adhered to as per manufacturer's instructions?		
The operation of the fire/convector heater and controls have been demonstrated and understood by the customer, including replacement of batteries?		
The manufacturer's literature, including Benchmark Checklist and Service record has been explained and left with the customer?		
Has the appliance been registered with the Local Authority, as detailed on the Gas Safe web site and is a legal requirement and forms part of the warranty?		
Commissioning Engineer's Signature		
Customer's Signature (To confirm satisfactory demonstration and receipt of manufacturer's literature)		

\*All installations in England and Wales must be notified to be Local Authority Building Control (LABC) either directly or through a Competent Persons Scheme. A Building Regulations Compliance Certificate will then be issued to the customer

# SERVICE RECORD

It is essential that your gas fire is serviced regularly and that the appropriate Service Interval Record is completed. Service Provider

Before completing the appropriate Service Record below, please ensure you have carried out the service as described in the manufacturer's instructions. Always use the manufacturer's specified spare part when replacing controls.



<b>SERVICE 01</b>	Date:
Engineer name:	
Company name:	
Telephone No:	
Gas safe register No:	
Comments:	
Signature	

<b>SERVICE 02</b>	Date:
Engineer name:	
Company name:	
Telephone No:	
Gas safe register No:	
Comments:	
Signature	

<b>SERVICE 03</b>	Date:
Engineer name:	
Company name:	
Telephone No:	
Gas safe register No:	
Comments:	
Signature	

<b>SERVICE 04</b>	Date:
Engineer name:	
Company name:	
Telephone No:	
Gas safe register No:	
Comments:	
Signature	

<b>SERVICE 05</b>	Date:
Engineer name:	
Company name:	
Telephone No:	
Gas safe register No:	
Comments:	
Signature	

Product ID Label		Serial No Prefix	
Core BF Remote Control	A-0804		TH
Data Badge			
Burner Tray / Box Assembly			
AAA Batteries x 2			
Embaglow			
Fixing Kit (A-0474)			
Grommet (4554)			
Silicone seal (4818)			
Connection Pipe			
7mm Nut Spinner			
Spare Fixings (Bagged) (A-0411)			
Air Test Completed			
Hand Remote (Bluetooth)			
Warning Label (Fire Guard)			
Magnets (4 x 3048) 			
9v Transformer			
Glass Assembly			
Canopy (4540) 			
Fret Plate 			
Owners Book			
Serial Number			
Inspector			